

MASTERTRACE™

HEAT TRACING CONTROL

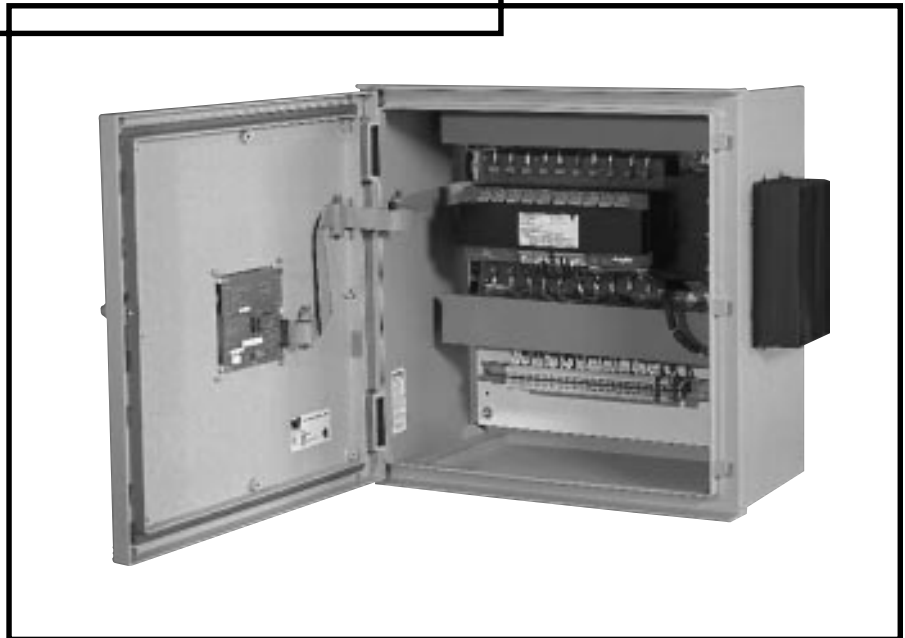

OPERATOR'S MANUAL

1 Overview	1.1
1.1 Use of This Manual	1.1
1.2 Related Documents	1.1
1.3 Conventions	1.1
1.4 Scope	1.1
2 Getting Started	2.1
2.1 Introduction	2.1
2.2 Enable Heaters	2.1
2.3 Enter Setpoints	2.2
2.4 Test Heater & Alarms	2.4
2.5 Monitor System Status	2.5
3 Product Description	3.1
3.1 Introduction	3.1
3.2 Features and Benefits	3.2
3.3 Control Module Specifications	3.3
3.4 Model Codes for Control Panels	3.14
4 Installation	4.1
4.1 Control Panel Mounting	4.1
4.2 RTD Sensor Wiring	4.1
4.3 Ground Fault Protection	4.1
4.4 Ground Fault Testing	4.1
4.5 Heater Wiring	4.1
4.6 Ground Connection	4.1
4.7 Safety Ground	4.1
4.8 Control Power Wiring	4.1
4.9 Commissioning	4.2
5 Operation	5.1
5.1 Control Modules	5.1
5.2 Interface Modules	5.5
5.3 Responding to Alarms	5.8
5.4 Setpoint Values Menu: Single-Phase Modules	5.9
5.5 Setpoint Values Menu: Three-Phase Modules (1- and 5-point only)	5.10
5.6 Measured Values Menu: Single-Phase Modules	5.11
5.7 Measured Values Menu: Three-Phase Modules	5.12
6 Programming & Setup	6.1
6.1 Getting Started	6.1
6.2 Program Enable	6.1
6.3 Module List (MR100 Group Interface)	6.1
6.4 Heater Enable	6.1
6.5 Example: Change the Setpoint for Heater 3-2 to 50 °C	6.1
7 Networking Modules	7.1
7.1 RS-485 Communications	7.1
7.2 RS-485 Wiring	7.2
7.3 Removing a Control Module from the Network	7.2
7.4 Adding a Control Module to the Network	7.2
7.5 Communication With Third Party Equipment	7.2
7.6 Baud Rate	7.2
8 Service & Testing	8.1
8.1 Troubleshooting Hints	8.1
8.2 Field Tests	8.1
8.3 Field Repairs	8.2

Appendix A Display Message Details - Setpoints A.1
Setpoints: Operating Values A.1
Setpoints: Heater Setup Menu A.7
Setpoints: System Setup Menu A.9
Setpoints: Test Menu A.17

Appendix B Display Message Detail - Measured B.1
Measured Values: Operating Values B.1
Measured Values: Statistics Menu B.3

Appendix C Summary of Alarms and their Causes C.1

Appendix D Typical Wiring Diagrams D.1
MS-1DXH0 D.1
MS-1TXH0 D.1
MS-1DIN2 D.1
MS-2DXH0 D.2
MS-2DIN2 D.2
MS-5ADXH0 D.2
MS-5ADIN2 D.3
MS-5ATXH0 D.3
MS-10ADXH0 D.4
MS-10ADIN2 D.4
Driving Contactors D.5
Serial Communications D.5

Warranty Back Cover

1 Overview

1.1 Use of This Manual

Reading a lengthy instruction manual on a new product is not a task most people enjoy. To speed things up, *Chapter 2, Getting Started*, provides a step-by-step tutorial for a heat trace application. *Chapter 4, Installation*, discusses important mounting and wiring issues for reliable operation. Detailed information relating to switch and output ratings, accuracy and so forth are detailed in *Section 3.3, Specification*. The remainder of this manual should be read and kept for reference to provide the maximum benefit of the MasterTrace Controls.

1.2 Related Documents

The following documents are attached with this manual and located inside the control panel.

- ♦ Layout Drawing(s)
- ♦ Wiring Diagram(s)

1.3 Conventions

The following conventions are used in this manual.

- ? User Changeable Values
- & Retrieved Data
- [] Key Press
- V~ VAC (AC Voltage)
- VDC (DC Voltage)



Warning Statement

1.4 Scope

This manual describes control panel installation, startup information and operation for:

- ♦ MasterTrace one and two point control modules
- ♦ MasterTrace Rev.A versions of five and ten point modules. These models are identified by the addition of the letter “A” in the model number. (ie: MS-5ADXH0, MS-10ADXH0). These models are not replacement compatible with previous models.
- ♦ MasterTrace local and remote display modules

1.5 Rev.A Enhancements

New enhanced Rev.A models have been introduced for five and ten point models. These models include MS-5ADXH0, MS-5ATXH0, MS-5ADIN2, MS-10ADXH0 and MS-10ADXH0 which replaces the previous models designated without the “A”.

A GF test function has been added to verify that GF monitoring is functional. The user may set the GF testing period and is notified if a GF test fails. GF monitoring is

very important in protecting plant equipment in the event of a GF which can cause fires . It is required by electrical code (NEC and CEC) on electric heat trace.

The overall height on external switching models MS-5ADXH0, MS-5ATXH0 and MS-10ADXH0 have been reduce by half from the previous models which will improve control panel servicing.

Service and replacement of control modules take minutes instead of hours with the addition of detachable terminals. All terminals can be unplugged without a screw driver.

1.6 Overall Enhancements

These enhancements pertain to all controller models described in this manual. These controllers are identified by the marking “REV. D1-xx-xx” on the product name-plate. Previous models identified by the marking “REV. D0-xx-xx” on the product nameplate do not contain these enhancements.

Alarm contacts have been changed on all controller models to one solid-state and one mechanical alarm contact. Each contact may be configured normally open or closed by the user. The mechanical contact is dual rated hazardous and ordinary areas. The alarm light indicator can be programmed by the user to turn on, off or flash on alarm.

Communication baud rate is user settable to one of the following: 600,1200, 2400, 4800 and 9600. Faster baud rates will provide quicker response times on the remote display.

The MS-xDXN0 type models which were used for external contactor drive instead of solid-state relays are discontinued for new applications. The MS-xDXH0 or MS-xADXH0 models which are used for external solid-state relays can also be used for driving contacts with the addition of the SSR/HCC board. More details on driving contacts with this board is shown in *Appendix D, page D5*. The MS-xDXN0 type models are still available for controller replacement.

1.6 Shipping Content

Control panels are usually packaged in a wooden crate, sealed in plastic to minimize possibility of damage. Check the crate for damage, or other signs of rough handling or abuse. If damaged, notify the shipping carrier at once.

Control Panel

Panel Drawings (Located inside the control panel)

Instruction Manual (Located inside the control panel)

Warranty Card (Located inside the control panel)

2 Getting Started

2.1 Introduction

MasterTrace™ has many features which can provide trouble-free operation of heat tracing installations. To realize all the capabilities of control, it is recommended that all sections of the instruction manual are read.

An example is presented to illustrate how MasterTrace™ set up and operation on a specific installation.

MasterTrace™ is easy to program and setting up a unit to your specific requirements should be straight forward. In this example an MS-10A control module and ML100/MR100 front panel display/keyboard module are mounted in an enclosure for control of 10 heavy oil feed lines. Consult *Appendix A and B* for further information on a specific message or instructions.

Setpoint	Required	Range
Fluid maintain temperature	50 °C	0-300°C/off /none
Low temperature alarm	35 °C	-50 to 300°C/off
High temperature alarm	no alarm	-50 to 300°C/off
Nominal heater current	5 amps	0.0 to 100.0A /off
Nominal heater voltage	115 VAC	100 to 600 Vac
Ground fault trip current	30 mA	10 to 1000mA /off
Ground fault alarm current	20 mA	10 to 1000mA /off
System exercise time interval	8 hours	1-24/off
Cost per Kilowatt hour	\$0.06	\$0.01-\$0.50
Heater name	HEAVY OIL LINE	16 characters

Example: Each heater will be programmed as:

Configuration:

- 1) 10 point panel and local display
- 2) 1 RTD per heater for temperature sensing
- 3) Mineral insulated (MI) cable is used for the heater.
- 4) Normally open alarm contact to remote programmable control
- 5) Solid state switching 120 Vac@20A
- 6) Northern climate installation outdoors.
Operating temperatures: -40° to +40 °C
NEMA-4 weatherproof enclosure.

Install and commission the control in the following order:

- STEP 1: Enable heaters (Section 2.2)
- STEP 2: Program setpoints (Section 2.3)
- STEP 3: Test heater and alarm operation (Section 2.4)
- STEP 4: Monitor system status (Section 2.5)

2.2 Enable Heaters

After each control has been programmed with it's unique address, it is necessary to indicate which units are connected to the system and should be controlled. This is done by enabling a heater circuit. To enable a heater circuit, the operator must specify the heater number.

Note: When programming controls on a multipoint system it is important that you always know which heater is being accessed. Otherwise it is possible to program the wrong heater control by accident.

Suppose in our example we have a 10-point controller with heaters; 1-1, 1-2, 1-3 and 1-4 wired and programmed. The remaining six unused heaters will be disabled and can be used for easy system expansion at a later date.

The user can determine which heater the display is selected to by pressing either the [SETPOINTS] key or the [MEASURED] key which will cause this message to be displayed (the 2nd line and heater number may be different):

SELECT HEATER: 1-1
NONAME

Use the [VALUE ↑] or [VALUE ↓] keys to select the appropriate heater number then press [STORE] to select a new heater.

For this example, press [SETPOINT], select heater 1-1 using [VALUE ↑] or [VALUE ↓] keys then press [STORE].

To enable a heater circuit, press the [SETPOINTS] key once to access the Setpoints Operating Values group of messages. Press [MESSAGE ↓] until a message similar to the following appears:



Use [VALUE ↑] or [VALUE ↓] keys to toggle Heater 1-1 between YES and NO. When YES is displayed, press [STORE].

Repeat this process, for the remaining heaters. For example, to enable heater 1-2, select heater 1-2 first, then press the [MESSAGE ↓] key to display:



Select YES, then press [STORE] to enable heater 1-2. Now that we have programmed control addresses and told the master display which heater circuits are enabled, we can program setpoints for each control. There are two ways to do this on a multipoint system. Either go through each control and program every value or choose a parameter like temperature and program each control with that parameter before proceeding with the next item.

2.3 Enter Setpoints

2.3.1 Program Enable: Since the heater control display and keypad are normally accessible to passers-by who may wish to read measured values, a program disable feature is used to prevent accidental changes to the setpoints. So before any setpoints can be entered, the PROGRAM ENABLE dip switch/terminals must be set in the ENABLE position. These dip switches/terminals are located on both the ML100 and MR100 display modules. Refer to figure 5.7 and 5.8 for the location of the dip switch and terminal.

When programming is complete, the PROGRAM ENABLE dip switch should be returned to the DISABLE position or the terminals jumpered to prevent accidental changes to the setpoint.

If you try and store a setpoint without the dip switch/terminals in the ENABLE position the setpoint will not be saved and this message will flash on the screen:



Now that the MasterTrace™ control is ready for programming, we will enter the setpoints for this example. For further information about the organization of all the messages or for details on the range and application of each message see Appendix A. It is not necessary to enter setpoints in any particular order and any setpoint can be changed later.

2.3.2 Temperature Units °C/°F: Temperature values can be displayed in degrees Celsius or Fahrenheit. In order to enter values in preferred units this selection will be entered first.

Press the [SETPOINTS] key 3 times for System Setup mode and [MESSAGE ↓] until the following message is displayed:

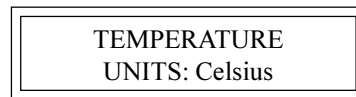

Press the [VALUE ↑] or [VALUE ↓] key to toggle selection between Celsius and Fahrenheit. When Celsius is displayed press [STORE]. A brief message appears:



Then the message reverts back to the previously entered value for verification. If instead you get the message:



then the PROGRAM ENABLE dip switch/terminals have not been set to the ENABLE position. This must be done to proceed with setpoint programming.

Assuming the setpoint was stored, all values will be displayed in °C. Temperature values can automatically be converted to °F at any time by selecting Fahrenheit using the Temperature Units message.

2.3.3 ASSIGN HEATER NAME: To assist operators in troubleshooting, each MasterTrace™ control can be programmed with a heater name. Up to 16 characters can be assigned to the name of each heater in a system. The same name can be used with different heaters although a unique name is preferable for clarity. Press [SETPOINTS] twice to enter the Heater Setup group of setpoints. Press the [MESSAGE ↵] key until the heater name message appears:

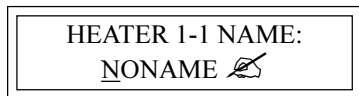

Note: The heater default name when MasterTrace™ is shipped from the factory is “NONAME”. Each letter can be programmed separately with upper and lower case characters, numbers, space or the special symbols !@#\$%^&*()?,.,”’;:}{. Uppercase characters are generally more legible.

For this example a name has arbitrarily been chosen as:

Name: HEAVY OIL LINE

The cursor appears under the first letter N. Each time the [STORE] key is pressed, the current letter displayed is saved and the cursor advances to the next letter. Hold down the [VALUE ↑] or [VALUE ↓] until the desired letter appears above the cursor, then press the [STORE] key. The cursor automatically advances to the next letter while saving the previous letter.

H: Press the [VALUE ↑] or [VALUE ↓] key until H appears. Press the [STORE] key. The letter H now appears in the first character position and the cursor is under the second character.

E: Press the [VALUE ↓] key until E appears. Press the [STORE] key. The first 2 letters are now HE and the cursor is under character position 3.

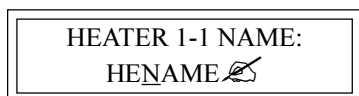

Continue entering each letter this way until the complete new name is displayed. With the cursor under the last character position at the right edge of the message screen (blank character) press the STORE key until the cursor is at the end of the line. A brief message will flash:



followed by the new name that has been stored:

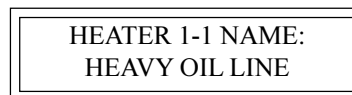

The new heater name is now saved in non-volatile memory and will remain until you change it.

If a character is accidentally entered incorrectly either press [RESET] to start over or go to the end of the line to save the displayed message with the error. Now press [MESSAGE ↑] or [MESSAGE ↵] to exit and return to the 1st character position. Then press [STORE] until the cursor is under the incorrect character. Proceed as before until new letters are entered. Press the [STORE] key to skip over the correct letters until on the last character position. Now press [STORE] to save the corrected message.

Setpoint information for system configuration and data for each heater can now be entered. Message summary and organization are located in Chapter 5. Detail description of setpoint messages is located in Appendix A. A few sample setpoints will be entered.

2.3.4 SETPOINT TEMPERATURE: The desired maintained temperature for the fluid in the pipe being traced is set by this heater on/off temperature setpoint. To display this message press the [SETPOINT] key once:



Press the [VALUE ↑] key once and notice that the displayed temperature increments by 1. Now hold down the [VALUE ↑] key and notice that after a short delay the displayed value increments rapidly. The [VALUE ↓] key works the same way. If you pass the required value, use [VALUE ↓] to decrease the number displayed.

Hold down the [VALUE ↑] key until 50 °C is displayed. Press the [STORE] key to save the new value. When a new value is successfully stored a brief acknowledgement message will flash on the screen:

SETPOINT
STORED

In this example, the temperature at which the control will turn on and supply full system voltage to the heater is now set to 50 °C.

At this point you can continue programming all remaining setpoints for this heater or you may prefer to program the setpoint temperature for all heaters and the next setpoint for all controls. To program the heater setpoint temperature of the next heater, 1-2, for example, press the [SETPOINT] key once, wait until the following message is displayed:

SELECT HTR: 1-2
NONAME

Use the [VALUE ↑] key to select the next heater 1-2 Now press [STORE]. All the heater setpoints and measured values displayed will pertain to heater 1-2. The message displayed is the setpoint temperature for that heater.

Assuming that each heater will be completely programmed before moving on to the next heater, press [MESSAGE ↓] after each setpoint to access the next setpoint. Hold the [VALUE ↑] key down until the word OFF appears to defeat any setpoint not required. For example, if a high current alarm is not useful set the alarm setting to off. Information about how to select each setpoint will be found in *Chapter 5: OPERATION*. A detailed description of each message is found in *Appendix A*. Consult these sections for an explanation of how to use each feature.

Setpoints entered in the groups “operating values” and “heater setup” apply only to the current heater address selected. Setpoints entered in the group “system setup” apply to all heaters controlled by the module. Since each module saves its setpoints independently, it is possible to inadvertently program modules with different system information. Ensure that each module is separately programmed with the same system setup information (e.g.. Cost per kilowatt hour) for consistent operation of a system with more than one control module.

2.4 Test Heater & Alarms

Heater and alarm outputs can be forced on using the test

mode. Like setpoints, this mode requires that the PROGRAM ENABLE dip switch/terminals be set to ENABLE or when you try to store a test value a message will flash:

NOT STORED -
PROG DISABLED

2.4.1 Heater Test: To test operation of a heater press the [SETPOINT] key 4 times and [MESSAGE ↓] until the following message is displayed:

MANUAL HEATER
DISABLED

Use the [VALUE ↑] or [VALUE ↓] keys to set the ON time in hours. The range is **DISABLED/1-24 hours/ON-CONTINUOUSLY**. To turn on the heater for one hour, press [VALUE ↑] to display ‘1 hour’ then press [STORE]. The heater will be energized no matter what the heater temperature setpoint is unless there is a ground fault trip. After the selected time period the heater will automatically go off.

While the heater is on, the front panel **HEATER ON** indicator will be illuminated. To override the test mode, press [VALUE ↓] until **DISABLE** appears and then store this value. Holding the [VALUE ↑] key until the word **ON CONTINUOUSLY** appears leaves the heater always energized until the MasterTrace™ control is manually powered off or until this setpoint is set to **DISABLE**. Consequently, selecting a value of **ON CONTINUOUSLY** should be used with caution since it overrides normal control operation and could lead to excessive heating or waste power if accidentally left on. A warning message will appear in the status mode whenever a heater or alarm is forced on.

With the heater forced on, verify that the expected current is flowing using the actual current message for that heater in the measured group. A clamp-on ammeter attached to one of the heater wires can be used to compare readings. With proportional control selected the readings may differ due to harmonics in the current waveform. Repeat this process for each heater on the system. As a safeguard, the heater will automatically timeout after the selected time and go back to automatic operation.

2.4.3 Alarm Test: The manual alarms setpoint works exactly like the manual heaters setpoint except that it energizes the output alarm and indicator. This setpoint is useful for commissioning a new system or checking alarm circuits. Normally this setpoint will be DISABLED.

2.5 Monitor System Status

Now that the MasterTrace™ control has been programmed for a specific application, system status can be checked. If no keys are pressed for the time specified in DISPLAY TIMEOUT in setpoints-system setup group of messages, the display will automatically go into the default message mode. In the System Status mode, the display will show any alarms on the system. If desired this could be changed to a specific message later by reprogramming the default message.

Measured values are accessed using the [MEASURED VALUES] key. These are divided into 2 groups. Pressing [MEASURED VALUES] once accesses the group of messages that show current values of temperature current etc. Pressing the [MEASURED VALUES] key twice will display the statistics data such as minimum/maximum temperature, power consumption, running hours etc. Unlike setpoints, measured values cannot be changed using the [VALUE ↑], [VALUE ↓] or [STORE] keys.

Note: A summary of all measured messages is provided in Appendix B. Press the [MEASURED] key and [MESSAGE ↓] to view each measured value for the selected heater.

All measured values displayed would be for heater 1-1. If you want to look at heater 1-2, press the [VALUE ↑] key to select heater 1-2 then press [STORE]. All measured values will now be for this heater. Press [MESSAGE ↓] to display the first measured value. Continue examining each value of interest by pressing the [MESSAGE ↓] key and referring to Chapter 5: OPERATION and Appendix B.

2.5.1 Heater Temperature: Press the [MEASURED] key once to get the first actual value and then [MESSAGE ↓] to display:

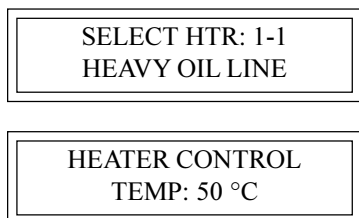

This is the actual temperature measured by the RTD temperature probe connected to the control. It represents the temperature at only one point on the pipe. The RTD probe will normally be placed at a location that best represents the average pipe temperature.

However, fluid temperature will vary somewhat along the pipe. If no RTD sensor is connected or a lead is broken the value “OPEN RTD” will appear. This is an alarm condition.

When the temperature falls below the heater setpoint, 50°C in our example, MasterTrace™ will switch on to supply power to the heater. It stays on until the temperature rises above the heater setpoint (50°C). Once the system has been running for a few hours the heater temperature should be at, or above, this setpoint value.

If hot fluid is being pumped through the pipe, the measured temperature may be much higher than the setpoint temperature. But in this case no power should be supplied to the heater as indicated by the front panel HEATER ON indicator being off.

If the heater temperature is less than the minimum display value (-50°C/-58°F) the word “RTD SHORT” appears. If the temperature is over the maximum value (+ 350°C / 662°F), the maximum value (i.e. 350°C) will be shown. If an abnormal value appears, particularly on a new installation, check that the correct RTD sensor type has been installed (100 OHM platinum DIN 43760) and that the three RTD wires are wired to the correct terminals.

2.5.2 Actual Current: Press [MESSAGE ↓] from the heater temperature message (or the [MEASURED] key then [MESSAGE ↓] several times) to display:



This value is the actual measured current of the heater. Resolution is to 0.5 amp over a range of 0.0 to 100.0 amps. Above 100.0 amps the value displayed reads O.L. (Overload). With MI (Mineral Insulated) cable used in this example it will either be 0.0 if the heater is not energized or a fairly constant current such as 5.0 amps.

2.5.3 Ground Fault Current: A small current will always flow to ground due to capacitance effects and leakage. Press the [MESSAGE ↓] key from the heater voltage message (or [MEASURED] then [MESSAGE ↓] several times) to display:



In this example, any value above 20mA would cause an alarm and if a ground fault current above 30mA were detected, MasterTrace™ would remove power to the heater. If the heater is off, the value displayed would be “0”. For values over 15 mA, check the system for insulation leakage problems.

All actual values have now been checked.

2.5.4 Statistical Data: In addition to actual values that are present, such as current and temperature, MasterTrace™ continuously gathers and computes historic information about the heat tracing system to determine cost of operation, utilization, trends etc. This can be quite useful in spotting potential problems or in designing similar systems for other applications. Information is stored for the last 24 hours to give an idea of current usage.

Pressing the [MESSAGE ↵] key from the measured value messages just displayed will take you to the statistics values group. A short-cut is to press the [MEASURED] key twice to display the first message in this group. Either way displays a brief message to indicate the start of the statistics page followed by the first value message:

MEASURED:
STATISTICS

Since this is a new installation any random data should be cleared. Press [MESSAGE ↵] in this group until the message appears:

RESET
STATISTICS: YES?

Reset statistics for a new measurement interval. Data can be read or cleared at any time to provide the most useful information. MasterTrace™ will keep track of when the measurement interval started. See *Chapter 5: Operation* and *Appendix B* for a complete description of how data is gathered and application ideas.

Important note:

If you clear statistics using an **ML100**, the statistics for all heaters will be cleared. However, if you clear statistics using **MR100**, only the statistics of the selected heater is cleared.

This completes setpoint programming and system testing. Set the PROGRAM ENABLE dip switch/terminals to DISABLE to prevent accidental setpoint changes or tampering. By following this sequence and message explanation it should be fairly easy to install a similar control application. Refer to *Appendix A* and *Appendix B* for further details.

As the system is used, some setpoints may need adjusting. For example, frequent low temperature alarms might indicate that the setpoint value was set too close to normal heater temperature swings and needs to be lowered.

3 Product Description

3.1 Introduction

Electric heat tracing control schemes have generally used some combination of mechanical thermostats, custom built control panels or programmable controls to provide the required level of control, monitoring and alarm functions. Budgetary constraints usually limit the degree of system fault monitoring to less than optimal levels. This results in periodic costly process shutdowns due to process or hardware malfunctions. Equipment reliability concerns often force plant procedures to include annual thermostat performance checks to ensure that the device is still operating as intended. This can be a tedious, labour intensive job.

The MasterTrace™ heat tracing system is a compatible family of electronic controls that uses state of the art technology to give complete control and central monitoring of electric heat tracing systems. MasterTrace™ can be used with MI, self-regulating and constant wattage cable. Individual smart controls mounted near to the pipe being traced can communicate with a single master unit to give complete system monitoring and control from a convenient location.

Continuous process and hardware monitoring with alarms for the complete system at a central point eliminates the need for annual maintenance checks. Overall system cost is lower than custom panels that have far less capability due to the many standard features incorporated into each control.

Figure 3.1 MasterTrace™ System Concept

Each heater point is monitored by a control mounted near the pipe being traced. Up to 300 points can be monitored by a single master conveniently located to allow quick system monitoring and fault diagnosis. A second RS485 port can be used for communication between controls and centralized monitoring. Each local control is completely independent and will continue to function if the master fails or if the communication link fails. This ensures maximum reliability and minimizes vulnerability in the event of a hardware failure. Additional points can be added at any time as easily as a mechanical thermostat can be installed. Unlike control schemes using programmable controllers, no software development is required. The complete system is operational as soon as it is installed.

To ensure that the MasterTrace™ heat tracing system will continue to meet the needs of plants as they upgrade to fully automated operation, an additional data highway can be implemented using the second RS485 port. By connecting controls to a programmable controller that is tied into a central plant computer, alarms caused by heat tracing malfunctions can immediately be flagged in a central control location. The complete system can be monitored and problem descriptions can be received for fast fault diagnosis and repair. In addition, the setpoints of any remote control can be altered by the master control (MR100) or a central computer (MC100). Heaters can be manually forced on and any pipe temperature can be read.

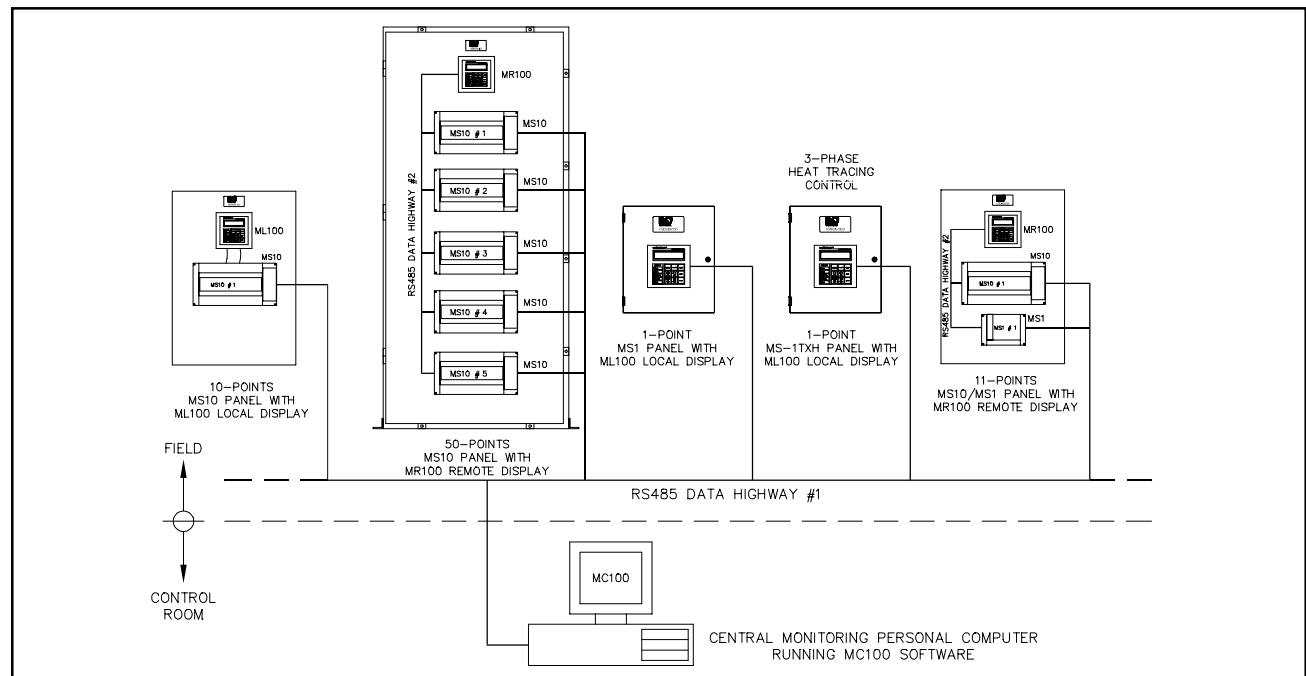

3.2 Features and Benefits

Requirements	MasterTrace Features
Temperature Control	0 to 300°C/32 to 572°F setpoint Digital temperature selection from keyboard 100 ohm platinum RTD sensor 3 wire, lead resistance compensation Proportional control with solid-state model
System Fault Alarms	User definable heater names on alarm display for fast fault location identification Normally open/normally closed alarm contacts Process Fault Alarms Breaker left off or tripped Low current High current alarm and trip Ground fault alarm and trip High temperature Low temperature Sensor open/short System OK and alarm indicators Hardware failure alarms Communication errors Self-test failure
Message Display	Actual Temperature Minimum and maximum temperature Heater current Ground fault current Heater power consumption Operating power cost Running hours All setpoints
Early Warning	TRACECHECK exercises dormant systems for early warning to prevent shutdowns Alpha-numeric display shows cause of alarm and heater location
Remote Monitoring	32 character display of all values in English Local or remote display and programming RS485 communication to remote monitor Alarm contacts for PC interface or remote indicator alarm
Verification	Measured temperature displayed and easily verified in the field Heater on indication for setpoint accuracy checking Precision components. No mechanical parts for calibration drift
Hazardous/Ordinary Area Mounting	Control Modules are CSA NRTL/C approved for ordinary or Class1, Div.II, Groups A,B,C,D or Class1 Zone 2, Group IIC hazardous areas -40 to +60 °C operating range Solid-state relay driver output or 30A/280 VAC internal mechanical relay Easy retrofit replacement for mechanical thermostats for system upgrading
Reliability	Calibration easy to verify with simple tools in the field Self test...hardware alarm Self contained local controls continue to function if master defective
Low Installed Cost	Competitively priced Compact, 10 points per MS-10 for large control panels Add additional points easily at any time Ground fault heater trip eliminates expensive ground fault circuit breaker Many standard features for most applications simplifies spare parts stocking Field programmable values easily changed

3.3 Control Module Specifications

3.3.1 MS-1DIN2 Control Module

Temperature Input

Range: -50°C to +350°C
 Accuracy: ±2°C
 Repeatability: ±1°C
 Sensor: Two 100 ohm, Platinum, 3-wire RTD per point
 20 ohm maximum lead resistance

Heater Switching

Number of Switches: One dual pole
 Switch Rating: 30A @ 280Vac max
 Current Measurement: 0.1 to 30A 3%±0.2A
 GF Measurement: 10 to 1000mA 5% ±2mA
 Voltage Measurement: 0 to 300Vac 3%±2V

Control Power

Power Requirements: 20VA @ 120Vac, 50 or 60Hz

Communications

Communication Ports: (1) Parallel Local Interface connection
 (2) Serial network connections

Serial Communications

Type: RS485
 Protocol: Modbus® RTU.
 Transmission Rate: 600, 1200, 2400, 4800, 9600 baud.
 Interconnect: 2-wire, shielded, twisted pair.
 Highway Distance: 4,000 feet without repeater.
 Modules per Highway: (1) Interface and (30) Control Modules.

Measured Values

Temperature: -50 to 350°C (-58 to 662°F)
 Minimum Temperature: -50 to 350°C (-58 to 662°F)
 Maximum Temperature: -50 to 350°C (-58 to 662°F)
 Heater Current: 0.1 to 100A
 Ground Fault Current: 0.01 to 1.0A
 Heater Voltage: 0 to 300Vac
 Heater Utilization: 0 to 100%
 Power Consumption: 0 to 1,000 MWh
 Operating Cost: 0 to \$1,000,000.00

Environment

Approval: CSA NRTL/C for Ordinary areas
 Operating Range: -40°C to +60°C
 Conformal Coating: Boards conformal coated for hostile environments

Alarm

Alarm Output: Programmable for NO or NC contacts
 One DC opto-isolated contact
 One dry mechanical contact
 Alarm Output Rating: DC contact: 30Vdc/0.1A, 500mW max
 Dry mech contact: 120Vac@1.0A max
 Alarm Light Output: LED Indicator: 12Vdc/30mA

Alarm Messages

Temperature: High Temperature Alarm
 Low Temperature Alarm
 Current: Low Current Alarm
 High Current Trip
 Ground Fault Current: Ground Fault Current Alarm
 Ground Fault Current Trip
 Voltage: Low Voltage Alarm
 Hardware: Self-Check Failure
 Switch Shorted
 RTD Open
 RTD Shorted

User-Settable Options

Heater Status: Enable or Disable
 Heater Name or Tag: 16 Character Alphanumeric
 Temperature Units: °C or °F
 Control Strategy: On or Off
 Deadband: 0 to 50C° (0-90F°)
 Temperature Setpoint: 0 to 300°C (32 to 572°F)
 High Temp Alarm: 0 to 300°C (32 to 572°F)
 Low Temp Alarm: -50 to 300°C (-58 to 572°F)
 High Current Alarm: 0.5 to 30A
 Low Current Alarm: 0.5 to 30A
 High Current Trip: 0.5 to 30A
 Ground Fault Alarm: 0.01 to 1.0A
 Ground Fault Trip: 0.01 to 1.0A
 TraceCheck Interval: 1 to 24 hr.
 Low Voltage Alarm: 0 to 300Vac
 RTD Control Strategy: Single, Backup, Highest, Lowest, Average or High Temperature Cutout
 RTD Fail-safe: Heater On or Heater Off
 Master Override Input: On or Off
 Alarm Contacts: NO or NC for each contact
 Alarm Light: Alarm on, Alarm off, Flash during alarm then on, Flash during alarm then off

Specifications subject to change without notice.

3.3.2 MS-1DXH0 Control Module

Temperature Input

Range: -50°C to +350°C
 Accuracy: ±2°C
 Repeatability: ±1°C
 Sensor: Two 100 ohm, Platinum, 3-wire RTD per point
 20 ohm maximum lead resistance

Current Input

Range: 0.1A to 100A
 Accuracy: 3%±0.2A
 Sensor: One current transformer

GF Input

Range: 10mA to 1000mA
 Accuracy: 5%±2mA
 Sensor: One current transformer

Voltage Input

Range: 0Vac to 300Vac
 Accuracy: 3%±2V
 Sensor: One voltage transformer

Heater Switching

No. of SSR Outputs: One
 SSR Output Rating: 12Vdc@15mA max output for driving external solid-state relays
 600Vac@100A max.
 GF CT will allow two conductors of O.D. 0.35" max.
 Heater Configuration: Single Phase

Control Power

Power Requirements: 15VA @ 120Vac, 50 or 60Hz

Communications

Communication Ports: (1) Parallel Local Interface connection
 (2) Serial network connections

Serial Communications

Type: RS485
 Protocol: Modbus® RTU.
 Transmission Rate: 1200, 2400, 4800, 9600 baud.
 Interconnect: 2-wire, shielded, twisted pair.
 Highway Distance: 4,000 feet without repeater.
 Modules per Highway: (1) Interface and (30) Control Modules.

Measured Values

Temperature: -50 to 350°C (-58 to 662°F)
 Minimum Temperature: -50 to 350°C (-58 to 662°F)
 Maximum Temperature: -50 to 350°C (-58 to 662°F)
 Heater Current: 0.1 to 100A
 Heater Percent Power: 0 to 100%
 Ground Fault Current: 0.01 to 1.0A
 Heater Voltage: 0 to 300Vac
 Heater Utilization: 0 to 100%
 Power Consumption: 0 to 1,000 MWh
 Operating Cost: 0 to \$1,000,000.00

Specifications subject to change without notice.

Environment

Approval: CSA NRTL/C
 Class1, Div.II, Groups A,B,C,D
 Class1 Zone 2, Group IIC
 Operating Range: -40°C to +60°C
 Conformal Coating: Boards conformal coated for hostile environments

Alarm

Alarm Output: Programmable for NO or NC contacts
 One DC opto-isolated contact
 One dry mechanical contact
 Alarm Output Rating:
 Hazardous Areas: DC contact: 30Vdc/0.1A, 500mW max
 Dry mech contact: 30Vdc@10mA max
 Ordinary Areas: DC contact: 30Vdc/0.1A, 500mW max
 Dry mech contact: 120Vac@1.0A max
 Alarm Light Output: LED Indicator: 12Vdc/30mA

Alarm Messages

Temperature: High Temperature Alarm
 Low Temperature Alarm
 Current: High Current Alarm
 Low Current Alarm
 High Current Trip
 Ground Fault Current: Ground Fault Current Alarm
 Ground Fault Current Trip
 Voltage: Low Voltage Alarm
 Hardware: Self-Check Failure
 Switch Shorted
 RTD Open
 RTD Shorted

User-Settable Options

Heater Status: Enable or Disable
 Heater Name or Tag: 16 Character Alphanumeric
 Temperature Units: °C or °F
 Control Strategy: On-Off or Proportional
 Deadband: 0 to 50°C (0-90°F)
 PowerLimit: 0.5 to 100A
 Temperature Setpoint: 0 to 300°C (32 to 572°F)
 High Temp Alarm: 0 to 300°C (32 to 572°F)
 Low Temp Alarm: -50 to 300°C (-58 to 572°F)
 High Current Alarm: 0.5 to 100A
 Low Current Alarm: 0.5 to 100A
 High Current Trip: 0.5 to 100A
 Ground Fault Alarm: 0.01 to 1.0A
 Ground Fault Trip: 0.01 to 1.0A
 TraceCheck Interval: 1 to 24 hr.
 Low Voltage Alarm: 0 to 300Vac
 RTD Control Strategy: Single, Backup, Highest, Lowest, Average or High Temperature Cutout
 Heater On or Heater Off
 RTD Fail-safe: Heater On or Heater Off
 Master Override Input: On or Off
 Alarm Contacts: NO or NC for each contact
 Alarm Light: Alarm on, Alarm off, Flash during alarm then on, Flash during alarm then off

3.3.3 MS-1TXH0 Control Module

Temperature Input

Range: -50°C to +350°C
 Accuracy: ±2°C
 Repeatability: ±1°C
 Sensor: Two 100 ohm, Platinum, 3-wire RTD per point
 20 ohm maximum lead resistance

Current Input

Range: 0.1A to 100A
 Accuracy: 3%±0.2A
 Sensor: Three current transformers

GF Input

Range: 10mA to 1000mA
 Accuracy: 5%±2mA
 Sensor: One current transformer

Heater Switching

No. of SSR Outputs: One
 SSR Output Rating: 12Vdc@15mA max output for driving external solid-state relays
 600Vac@100A max.
 GF CT will allow three conductors of O.D 0.32" max.
 Heater Configuration: Three Phase

Control Power

Power Requirements: 15VA @ 120Vac, 50 or 60Hz

Communications

Communication Ports: (1) Parallel Local Interface connection
 (2) Serial network connections

Serial Communications

Type: RS485
 Protocol: Modbus® RTU.
 Transmission Rate: 600, 1200, 2400, 4800, 9600 baud.
 Interconnect: 2-wire, shielded, twisted pair.
 Highway Distance: 4,000 feet without repeater.
 Modules per Highway: (1) Interface and (30) Control Modules.

Measured Values

Temperature: -50 to 350°C (-58 to 662°F)
 Minimum Temperature: -50 to 350°C (-58 to 662°F)
 Maximum Temperature: -50 to 350°C (-58 to 662°F)
 Heater Current: 0.1 to 100A
 Heater Percent Power: 0 to 100%
 Ground Fault Current: 0.01 to 1.0A
 Heater Utilization: 0 to 100%
 Power Consumption: 0 to 1,000 MWh
 Operating Cost: 0 to \$1,000,000.00

Environment

Approval: CSA NRTL/C
 Class1, Div.II, Groups A,B,C,D
 Class1 Zone 2, Group IIC
 Operating Range: -40°C to +60°C
 Conformal Coating: Boards conformal coated for hostile environments

Alarm

Alarm Output: Programmable for NO or NC contacts
 One DC opto-isolated contact
 One dry mechanical contact

Alarm Output Rating:
 Hazardous Areas: DC contact: 30Vdc/0.1A, 500mW max
 Dry mech contact: 30Vdc@10mA max
 Ordinary Areas: DC contact: 30Vdc/0.1A, 500mW max
 Dry mech contact: 120Vac@1.0A max
 Alarm Light Output: LED Indicator: 12Vdc/30mA

Alarm Messages

Temperature: High Temperature Alarm
 Low Temperature Alarm
 Current: High Current Alarm
 Low Current Alarm
 High Current Trip
 Ground Fault Current: Ground Fault Current Alarm
 Ground Fault Current Trip
 Hardware: Self-Check Failure
 Switch Shorted
 RTD Open
 RTD Shorted

User-Settable Options

Heater Status: Enable or Disable
 Heater Name or Tag: 16 Character Alphanumeric
 Temperature Units: °C or °F
 Control Strategy: On-Off or Proportional
 Deadband: 0 to 50C° (0-90F°)
 PowerLimit: 0.5 to 100A
 Temperature Setpoint: 0 to 300°C (32 to 572°F)
 High Temp Alarm: 0 to 300°C (32 to 572°F)
 Low Temp Alarm: -50 to 300°C (-58 to 572°F)
 High Current Alarm: 0.5 to 100A
 Low Current Alarm: 0.5 to 100A
 High Current Trip: 0.5 to 100A
 Ground Fault Alarm: 0.01 to 1.0A
 Ground Fault Trip: 0.01 to 1.0A
 TraceCheck Interval: 1 to 24 hr.
 RTD Control Strategy: Single, Backup, Highest, Lowest, Average or High Temperature Cutout
 Heater On or Heater Off
 RTD Fail-safe: On or Off
 Master Override Input: On or Off
 Alarm Contacts: NO or NC for each contact
 Alarm Light: Alarm on, Alarm off, Flash during alarm then on, Flash during alarm then off

Specifications subject to change without notice.

3.3.4 MS-2DIN2 Control Module

Temperature Input

Range: -50°C to +350°C
 Accuracy: ±2°C
 Repeatability: ±1°C
 Sensor: Two 100 ohm, Platinum, 3-wire RTD;
 One per point
 20 ohm maximum lead resistance

Heater Switching

Number of Switches: Two dual pole
 Switch Rating: 30A @ 280Vac max
 Current Measurement: 0.1 to 30A 3%±0.2A
 GF Measurement: 10 to 1000mA 5%±5mA
 Voltage Measurement: 0 to 300Vac 3%±2V

Control Power

Power Requirements: 15VA @ 120Vac, 50 or 60Hz

Communications

Communication Ports: (1) Parallel Local Interface connection
 (2) Serial network connections

Serial Communications

Type: RS485
 Protocol: Modbus® RTU.
 Transmission Rate: 600, 1200, 2400, 4800, 9600 baud.
 Interconnect: 2-wire, shielded, twisted pair.
 Highway Distance: 4,000 feet without repeater.
 Modules per Highway: (1) Interface and (30) Control Modules.

Measured Values

Temperature: -50 to 350°C (-58 to 662°F)
 Minimum Temperature: -50 to 350°C (-58 to 662°F)
 Maximum Temperature: -50 to 350°C (-58 to 662°F)
 Heater Current: 0.1 to 100A
 Ground Fault Current: 0.01 to 1.0A
 Heater Voltage: 0 to 300Vac
 Heater Utilization: 0 to 100%
 Power Consumption: 0 to 1,000 MWh
 Operating Cost: 0 to \$1,000,000.00

Environment

Approval: CSA NRTL/C for Ordinary areas
 Operating Range: -40°C to +60°C
 Conformal Coating: Boards conformal coated for hostile environments

Alarm

Alarm Output: Programmable for NO or NC contacts
 One DC opto-isolated contact
 One dry mechanical contact
 Alarm Output Rating: DC contact: 30Vdc/0.1A, 500mW max
 Dry mech contact: 120Vac@1.0A max
 Alarm Light Output: LED Indicator: 12Vdc/30mA

Alarm Messages

Temperature: High Temperature Alarm
 Low Temperature Alarm
 Current: High Current Alarm
 Low Current Alarm
 High Current Trip
 Ground Fault Current: Ground Fault Current Alarm
 Ground Fault Current Trip
 Voltage: Low Voltage Alarm
 Hardware: Self-Check Failure
 Switch Shorted
 RTD Open
 RTD Shorted

User-Settable Options

Heater Status: Enable or Disable
 Heater Name or Tag: 16 Character Alphanumeric
 Temperature Units: °C or °F
 Control Strategy: On-Off
 Deadband: 0 to 50°C (0-90°F)
 StaggerStart: On or Off
 Temperature Setpoint: 0 to 300°C (32 to 572°F)
 High Temp Alarm: 0 to 300°C (32 to 572°F)
 Low Temp Alarm: -50 to 300°C (-58 to 572°F)
 High Current Alarm: 0.5 to 30A
 Low Current Alarm: 0.5 to 30A
 High Current Trip: 0.5 to 30A
 Ground Fault Alarm: 0.01 to 1.0A
 Ground Fault Trip: 0.01 to 1.0A
 TraceCheck Interval: 1 to 24 hr.
 Low Voltage Alarm: 0 to 300Vac
 RTD Fail-safe: Heater On or Heater Off
 Master Override Input: On or Off
 Alarm Contacts: NO or NC for each contact
 Alarm Light: Alarm on, Alarm off, Flash during alarm then on, Flash during alarm then off

Specifications subject to change without notice.

3.3.5 MS-2DXH0 Control Module

Temperature Input

Range: -50°C to +350°C
 Accuracy: ±2°C
 Repeatability: ±1°C
 Sensor: Two 100 ohm, Platinum, 3-wire RTD;
 one per point
 20 ohm maximum lead resistance

Current Input

Range: 0.1A to 100A
 Accuracy: 3%±0.2A
 Sensor: Two current transformers; one per point

GF Input

Range: 10mA to 1000mA
 Accuracy: 5%±2mA
 Sensor: Two current transformers; one per point

Voltage Input

Range: 0Vac to 300Vac
 Accuracy: 3%±2V
 Sensor: Two voltage transformers; one per point

Heater Switching

No. of SSR Outputs: Two
 SSR Output Rating: 12Vdc@15mA max output for driving
 external solid-state relays
 600Vac@100A max.
 GF CT will allow two conductors of O.D.
 0.35" max.
 Heater Configuration: Single Phase

Control Power

Power Requirements: 15VA @ 120Vac, 50 or 60Hz

Communications

Communication Ports: (1) Parallel Local Interface connection
 (2) Serial network connections

Serial Communications

Type: RS485
 Protocol: Modbus® RTU.
 Transmission Rate: 600, 1200, 2400, 4800, 9600 baud.
 Interconnect: 2-wire, shielded, twisted pair.
 Highway Distance: 4,000 feet without repeater.
 Modules per Highway: (1) Interface and (30) Control Modules.

Measured Values

Temperature: -50 to 350°C (-58 to 662°F)
 Minimum Temperature: -50 to 350°C (-58 to 662°F)
 Maximum Temperature: -50 to 350°C (-58 to 662°F)
 Heater Current: 0.1 to 100A
 Heater Percent Power: 0 to 100%
 Ground Fault Current: 0.01 to 1.0A
 Heater Voltage: 0 to 300Vac
 Heater Utilization: 0 to 100%
 Power Consumption: 0 to 1,000 MWh
 Operating Cost: 0 to \$1,000,000.00

Specifications subject to change without notice.

Environment

Approval: CSA NRTL/C
 Class1, Div.II, Groups A,B,C,D
 Class1 Zone 2, Group IIC
 Operating Range: -40°C to +60°C
 Conformal Coating: Boards conformal coated for hostile environments

Alarm

Alarm Output: Programmable for NO or NC contacts
 One DC opto-isolated contact
 One dry mechanical contact
 Alarm Output Rating:
 Hazardous Areas: DC contact: 30Vdc/0.1A, 500mW max
 Dry mech contact: 30Vdc@10mA max
 Ordinary Areas: DC contact: 30Vdc/0.1A, 500mW max
 Dry mech contact: 120Vac@1.0A max
 Alarm Light Output: LED Indicator: 12Vdc/30mA

Alarm Messages

Temperature: High Temperature Alarm
 Low Temperature Alarm
 Current: High Current Alarm
 Low Current Alarm
 High Current Trip
 Ground Fault Current: Ground Fault Current Alarm
 Ground Fault Current Trip
 Voltage: Low Voltage Alarm
 Hardware: Self-Check Failure
 Switch Shorted
 RTD Open
 RTD Shorted

User-Settable Options

Heater Status: Enable or Disable
 Heater Name or Tag: 16 Character Alphanumeric
 Temperature Units: °C or °F
 Control Strategy: On-Off or Proportional
 Deadband: 0 to 50C° (0-90F°)
 StaggerStart: On or Off
 PowerLimit: 0.5 to 100A
 Temperature Setpoint: 0 to 300°C (32 to 572°F)
 High Temp Alarm: 0 to 300°C (32 to 572°F)
 Low Temp Alarm: -50 to 300°C (-58 to 572°F)
 High Current Alarm: 0.5 to 100A
 Low Current Alarm: 0.5 to 100A
 High Current Trip: 0.5 to 100A
 Ground Fault Alarm: 0.01 to 1.0A
 Ground Fault Trip: 0.01 to 1.0A
 TraceCheck Interval: 1 to 24 hr.
 Low Voltage Alarm: 0 to 300Vac
 RTD Fail-safe: Heater On or Heater Off
 Master Override Input: On or Off
 Alarm Contacts: NO or NC for each contact
 Alarm Light: Alarm on, Alarm off, Flash during alarm then on, Flash during alarm then off

3.3.6 MS-5ADIN2 Control Module

Temperature Input

Range: -50°C to +350°C
 Accuracy: ±2°C
 Repeatability: ±1°C
 Sensor: Ten 100 ohm, Platinum, 3-wire RTD;
 two per point
 20 ohm maximum lead resistance

Heater Switching

Number of Switches: Five dual pole
 Switch Rating: 30A @ 280Vac max
 Current Measurement: 0.1 to 30A 3%±0.2A
 GF Measurement: 10 to 1000mA 5%±2mA

Ground Fault

Maximum Trip Time: 13.7 seconds

Control Power

Power Requirements: 35VA @ 120Vac, 50 or 60Hz

Communications

Communication Ports: (1) Parallel Local Interface connection
 (2) Serial network connections

Serial Communications

Type: RS485
 Protocol: Modbus® RTU.
 Transmission Rate: 600, 1200, 2400, 4800, 9600 baud.
 Interconnect: 2-wire, shielded, twisted pair.
 Highway Distance: 4,000 feet without repeater.
 Modules per Highway: (1) Interface and (30) Control Modules.

Measured Values

Temperature: -50 to 350°C (-58 to 662°F)
 Minimum Temperature: -50 to 350°C (-58 to 662°F)
 Maximum Temperature: -50 to 350°C (-58 to 662°F)
 Heater Current: 0.1 to 100A
 Ground Fault Current: 0.01 to 1.0A
 Heater Utilization: 0 to 100%
 Power Consumption: 0 to 1,000 MWh
 Operating Cost: 0 to \$1,000,000.00

Environment

Approval: CSA NRTL/C for Ordinary areas
 Operating Range: -40°C to +60°C
 Conformal Coating: Boards conformal coated for hostile environments

Alarm

Alarm Output: Programmable for NO or NC contacts
 One DC opto-isolated contact
 One dry mechanical contact
 Alarm Output Rating: DC contact: 30Vdc/0.1A, 500mW max
 Dry mech contact: 120Vac@1.0A max
 Alarm Light Output: LED Indicator: 12Vdc/30mA

Alarm Messages

Temperature: High Temperature Alarm
 Low Temperature Alarm
 Current: High Current Alarm
 Low Current Alarm
 High Current Trip
 Ground Fault Current: Ground Fault Current Alarm
 Ground Fault Current Trip
 Hardware: Self-Check Failure
 Switch Shorted
 RTD Open
 RTD Shorted

User-Settable Options

Heater Status: Enable or Disable
 Heater Name or Tag: 16 Character Alphanumeric
 Temperature Units: °C or °F
 Control Strategy: On-Off
 Deadband: 0 to 50C° (0-90F°)
 StaggerStart: On or Off
 Temperature Setpoint: 0 to 300°C (32 to 572°F)
 High Temp Alarm: 0 to 300°C (32 to 572°F)
 Low Temp Alarm: -50 to 300°C (-58 to 572°F)
 High Current Alarm: 0.5 to 30A
 Low Current Alarm: 0.5 to 30A
 High Current Trip: 0.5 to 30A
 Ground Fault Alarm: 0.01 to 1.0A
 Ground Fault Trip: 0.01 to 1.0A
 TraceCheck Interval: 1 to 24 hr.
 RTD Control Strategy: Single, Backup, Highest, Lowest,
 Average or High Temperature Cutout
 Heater On or Heater Off
 RTD Fail-safe:
 Master Override Input: On or Off
 Alarm Contacts: NO or NC for each contact
 Alarm Light: Alarm on, Alarm off, Flash during alarm
 then on, Flash during alarm then off
 GF Test: 1 to 24hrs, test now

Specifications subject to change without notice.

3.3.7 MS-5ADXH0 Control Module

Temperature Input

Range: -50°C to +350°C
 Accuracy: ±2°C
 Repeatability: ±1°C
 Sensor: Ten 100 ohm, Platinum, 3-wire RTD;
 two per point
 20 ohm maximum lead resistance

Current Input

Range: 0.1A to 100A
 Accuracy: 3%±0.2A
 Sensor: Five current transformers; one per point

GF Input

Range: 10mA to 1000mA
 Accuracy: 5%±2mA
 Sensor: Five current transformers; one per point
 Maximum Trip Time: 14.1 seconds

Heater Switching

No. of SSR Outputs: Five
 SSR Output Rating: 12Vdc@15mA max output for driving
 external solid-state relays
 600Vac@100A max.
 GF CT will allow two conductors of O.D.
 0.35" max.
 Heater Configuration: Single Phase

Control Power

Power Requirements: 15VA @ 120Vac, 50 or 60Hz

Communications

Communication Ports: (1) Parallel Local Interface connection
 (2) Serial network connections

Serial Communications

Type: RS485
 Protocol: Modbus® RTU.
 Transmission Rate: 600, 1200, 2400, 4800, 9600 baud.
 Interconnect: 2-wire, shielded, twisted pair.
 Highway Distance: 4,000 feet without repeater.
 Modules per Highway: (1) Interface and (30) Control Modules.

Measured Values

Temperature: -50 to 350°C (-58 to 662°F)
 Minimum Temperature: -50 to 350°C (-58 to 662°F)
 Maximum Temperature: -50 to 350°C (-58 to 662°F)
 Heater Current: 0.1 to 100A
 Heater Percent Power: 0 to 100%
 Ground Fault Current: 0.01 to 1.0A
 Heater Utilization: 0 to 100%
 Power Consumption: 0 to 1,000 MWh
 Operating Cost: 0 to \$1,000,000.00

Environment

Approval: CSA NRTL/C
 Class1, Div.II, Groups A,B,C,D
 Class1 Zone 2, Group IIC
 Operating Range: -40°C to +60°C
 Conformal Coating: Boards conformal coated for hostile
 environments

Alarm

Alarm Output: Programmable for NO or NC contacts
 One DC opto-isolated contact
 One dry mechanical contact

Alarm Output Rating:
 Hazardous Areas: DC contact: 30Vdc/0.1A, 500mW max
 Dry mech contact: 30Vdc@10mA max
 Ordinary Areas: DC contact: 30Vdc/0.1A, 500mW max
 Dry mech contact: 120Vac@1.0A max
 Alarm Light Output: LED Indicator: 12Vdc/30mA

Alarm Messages

Temperature: High Temperature Alarm
 Low Temperature Alarm
 Current: High Current Alarm
 Low Current Alarm
 High Current Trip
 Ground Fault Current: Ground Fault Current Alarm
 Ground Fault Current Trip
 Hardware: Self-Check Failure
 Switch Shorted
 RTD Open
 RTD Shorted

User-Settable Options

Heater Status: Enable or Disable
 Heater Name or Tag: 16 Character Alphanumeric
 Temperature Units: °C or °F
 Control Strategy: On-Off or Proportional
 Deadband: 0 to 50C° (0-90F°)
 StaggerStart: On or Off
 PowerLimit: 0.5 to 100A
 Temperature Setpoint: 0 to 300°C (32 to 572°F)
 High Temp Alarm: 0 to 300°C (32 to 572°F)
 Low Temp Alarm: -50 to 300°C (-58 to 572°F)
 High Current Alarm: 0.5 to 100A
 Low Current Alarm: 0.5 to 100A
 High Current Trip: 0.5 to 100A
 Ground Fault Alarm: 0.01 to 1.0A
 Ground Fault Trip: 0.01 to 1.0A
 TraceCheck Interval: 1 to 24 hr.
 RTD Control Strategy: Single, Backup, Highest, Lowest,
 Average or High Temperature Cutout
 Heater On or Heater Off
 RTD Fail-safe:
 Master Override Input: On or Off
 Alarm Contacts: NO or NC for each contact
 Alarm Light: Alarm on, Alarm off, Flash during alarm
 then on, Flash during alarm then off
 GF Test: 1 to 24hrs, test now

Specifications subject to change without notice.

3.3.8 MS-5ATXH0 Control Module

Temperature Input

Range: -50°C to +350°C
 Accuracy: ±2°C
 Repeatability: ±1°C
 Sensor: Ten 100 ohm, Platinum, 3-wire RTD;
 two per point
 20 ohm maximum lead resistance

Current Input

Range: 0.1A to 100A
 Accuracy: 3%±0.2A
 Sensor: Fifteen current transformers; three per point

GF Input

Range: 10mA to 1000mA
 Accuracy: 5%±2mA
 Sensor: Five current transformers; one per point
 Maximum Trip Time: 18.2 seconds

Heater Switching

No. of SSR Outputs: Five
 SSR Output Rating: 12Vdc@15mA max output for driving external solid-state relays
 600Vac@100A max.
 GF CT will allow three conductors of O.D. 0.32" max.
 Heater Configuration: Three Phase

Control Power

Power Requirements: 15VA @ 120Vac, 50 or 60Hz

Communications

Communication Ports: (1) Parallel Local Interface connection
 (2) Serial network connections

Serial Communications

Type: RS485
 Protocol: Modbus® RTU.
 Transmission Rate: 600, 1200, 2400, 4800, 9600 baud.
 Interconnect: 2-wire, shielded, twisted pair.
 Highway Distance: 4,000 feet without repeater.
 Modules per Highway: (1) Interface and (30) Control Modules.

Measured Values

Temperature: -50 to 350°C (-58 to 662°F)
 Minimum Temperature: -50 to 350°C (-58 to 662°F)
 Maximum Temperature: -50 to 350°C (-58 to 662°F)
 Heater Current: 0.1 to 100A
 Heater Percent Power: 0 to 100%
 Ground Fault Current: 0.01 to 1.0A
 Heater Utilization: 0 to 100%
 Power Consumption: 0 to 1,000 MWh
 Operating Cost: 0 to \$1,000,000.00

Environment

Approval: CSA NRTL/C
 Class1, Div.II, Groups A,B,C,D
 Class1 Zone 2, Group IIC
 Operating Range: -40°C to +60°C
 Conformal Coating: Boards conformal coated for hostile environments

Alarm

Alarm Output: Programmable for NO or NC contacts
 One DC opto-isolated contact
 One dry mechanical contact
 Alarm Output Rating:
 Hazardous Areas: DC contact: 30Vdc/0.1A, 500mW max
 Dry mech contact: 30Vdc@10mA max
 Ordinary Areas: DC contact: 30Vdc/0.1A, 500mW max
 Dry mech contact: 120Vac@1.0A max
 Alarm Light Output: LED Indicator: 12Vdc/30mA

Alarm Messages

Temperature: High Temperature Alarm
 Low Temperature Alarm
 Current: High Current Alarm
 Low Current Alarm
 High Current Trip
 Ground Fault Current: Ground Fault Current Alarm
 Ground Fault Current Trip
 Hardware: Self-Check Failure
 Switch Shorted
 RTD Open
 RTD Shorted

User-Settable Options

Heater Status: Enable or Disable
 Heater Name or Tag: 16 Character Alphanumeric
 Temperature Units: °C or °F
 Control Strategy: On-Off or Proportional
 Deadband: 0 to 50C° (0-90F°)
 StaggerStart: On or Off
 PowerLimit: 0.5 to 100A
 Temperature Setpoint: 0 to 300°C (32 to 572°F)
 High Temp Alarm: 0 to 300°C (32 to 572°F)
 Low Temp Alarm: -50 to 300°C (-58 to 572°F)
 High Current Alarm: 0.5 to 100A
 Low Current Alarm: 0.5 to 100A
 High Current Trip: 0.5 to 100A
 Ground Fault Alarm: 0.01 to 1.0A
 Ground Fault Trip: 0.01 to 1.0A
 TraceCheck Interval: 1 to 24 hr.
 RTD Control Strategy: Single, Backup, Highest, Lowest, Average or High Temperature Cutout
 Heater On or Heater Off
 RTD Fail-safe:
 Master Override Input: On or Off
 Alarm Contacts: NO or NC for each contact
 Alarm Light: Alarm on, Alarm off, Flash during alarm then on, Flash during alarm then off
 GF Test: 1 to 24hrs, test now

Specifications subject to change without notice.

3.3.9 MS-10ADIN2

Temperature Input

Range: -50°C to +350°C
 Accuracy: ±2°C
 Repeatability: ±1°C
 Sensor: Ten 100 ohm, Platinum, 3-wire RTD;
 one per point
 20 ohm maximum lead resistance

Heater Switching

Number of Switches: Ten dual pole
 Switch Rating: 30A @ 280Vac max
 Current Measurement: 0.1 to 30A 3%±0.2A
 GF Measurement: 10 to 1000mA 5%±2mA

Control Power

Power Requirements: 50VA @ 120Vac, 50 or 60Hz

Communications

Communication Ports: (1) Parallel Local Interface connection
 (2) Serial network connections

Serial Communications

Type: RS485
 Protocol: Modbus® RTU.
 Transmission Rate: 600, 1200, 2400, 4800, 9600 baud.
 Interconnect: 2-wire, shielded, twisted pair.
 Highway Distance: 4,000 feet without repeater.
 Modules per Highway: (1) Interface and (30) Control Modules.

Measured Values

Temperature: -50 to 350°C (-58 to 662°F)
 Minimum Temperature: -50 to 350°C (-58 to 662°F)
 Maximum Temperature: -50 to 350°C (-58 to 662°F)
 Heater Current: 0.1 to 100A
 Ground Fault Current: 0.01 to 1.0A
 Power Consumption: 0 to 1,000 MWh
 Heater Utilization: 0 to 100%
 Operating Cost: 0 to \$1,000,000.00

Ground Fault

Maximum Trip Time: 24.5 seconds

Environment

Approval: CSA NRTL/C for Ordinary areas
 Operating Range: -40°C to +60°C
 Conformal Coating: Boards conformal coated for hostile environments

Alarm

Alarm Output: Programmable for NO or NC contacts
 One DC opto-isolated contact
 One dry mechanical contact
 Alarm Output Rating: DC contact: 30Vdc/0.1A, 500mW max
 Dry mech contact: 120Vac@1.0A max
 Alarm Light Output: LED Indicator: 12Vdc/30mA

Alarm Messages

Temperature: High Temperature Alarm
 Low Temperature Alarm
 Current: High Current Alarm
 Low Current Alarm
 High Current Trip
 Ground Fault Current: Ground Fault Current Alarm
 Ground Fault Current Trip
 Hardware: Self-Check Failure
 Switch Shorted
 RTD Open
 RTD Shorted

User-Settable Options

Heater Status: Enable or Disable
 Heater Name or Tag: 16 Character Alphanumeric
 Temperature Units: °C or °F
 Control Strategy: On-Off
 Deadband: 0 to 50°C (0-90°F)
 StaggerStart: On or Off
 Temperature Setpoint: 0 to 300°C (32 to 572°F)
 High Temp Alarm: 0 to 300°C (32 to 572°F)
 Low Temp Alarm: -50 to 300°C (-58 to 572°F)
 High Current Alarm: 0.5 to 30A
 Low Current Alarm: 0.5 to 30A
 High Current Trip: 0.5 to 30A
 Ground Fault Alarm: 0.01 to 1.0A
 Ground Fault Trip: 0.01 to 1.0A
 TraceCheck Interval: 1 to 24 hr.
 RTD Fail-safe: Heater On or Heater Off
 Master Override Input: On or Off
 Alarm Contacts: NO or NC for each contact
 Alarm Light: Alarm on, Alarm off, Flash during alarm
 then on, Flash during alarm then off
 GF Test: 1 to 24hrs, test now

Specifications subject to change without notice.

3.3.10 MS-10ADXH0 Control Module

Temperature Input

Range: -50°C to +350°C
 Accuracy: ±2°C
 Repeatability: ±1°C
 Sensor: Ten 100 ohm, Platinum, 3-wire RTD; one per point
 20 ohm maximum lead resistance

Current Input

Range: 0.1A to 100A
 Accuracy: 3%±0.2A
 Sensor: Ten current transformers; one per point

GF Input

Range: 10mA to 1000mA
 Accuracy: 5%±2mA
 Sensor: Ten current transformers; one per point
 Maimum Trip Time: 13.7 seconds

Heater Switching

No. of SSR Outputs: Ten
 SSR Output Rating: 12Vdc@15mA max output for driving external solid-state relays
 600Vac@100A max.
 GF CT will allow two conductors of O.D. 0.35" max.
 Heater Configuration: Single Phase

Control Power

Power Requirements: 15VA @ 120Vac, 50 or 60Hz

Communications

Communication Ports: (1) Parallel Local Interface connection
 (2) Serial network connections

Serial Communications

Type: RS485
 Protocol: Modbus® RTU.
 Transmission Rate: 600, 1200, 2400, 4800, 9600 baud.
 Interconnect: 2-wire, shielded, twisted pair.
 Highway Distance: 4,000 feet without repeater.
 Modules per Highway: (1) Interface and (30) Control Modules.

Measured Values

Temperature: -50 to 350°C (-58 to 662°F)
 Minimum Temperature: -50 to 350°C (-58 to 662°F)
 Maximum Temperature: -50 to 350°C (-58 to 662°F)
 Heater Current: 0.1 to 100A
 Heater Percent Power: 0 to 100%
 Ground Fault Current: 0.01 to 1.0A
 Heater Utilization: 0 to 100%
 Power Consumption: 0 to 1,000 MWh
 Operating Cost: 0 to \$1,000,000.00

Environment

Approval: CSA NRTL/C
 Class1, Div.II, Groups A,B,C,D
 Class1 Zone 2, Group IIC
 Operating Range: -40°C to +60°C
 Conformal Coating: Boards conformal coated for hostile environments

Alarm

Alarm Output: Programmable for NO or NC contacts
 One DC opto-isolated contact
 One dry mechanical contact
 Alarm Output Rating:
 Hazardous Areas: DC contact: 30Vdc/0.1A, 500mW max
 Dry mech contact: 30Vdc@10mA max
 Ordinary Areas: DC contact: 30Vdc/0.1A, 500mW max
 Dry mech contact: 120Vac@1.0A max
 Alarm Light Output: LED Indicator: 12Vdc/30mA

Alarm Messages

Temperature: High Temperature Alarm
 Low Temperature Alarm
 Current: High Current Alarm
 Low Current Alarm
 High Current Trip
 Ground Fault Current: Ground Fault Current Alarm
 Ground Fault Current Trip
 Hardware: Self-Check Failure
 Switch Shorted
 RTD Open
 RTD Shorted

User-Settable Options

Heater Status: Enable or Disable
 Heater Name or Tag: 16 Character Alphanumeric
 Temperature Units: °C or °F
 Control Strategy: On-Off or Proportional
 Deadband: 0 to 50°C (0-90°F)
 StaggerStart: On or Off
 PowerLimit: 0.5 to 100A
 Temperature Setpoint: 0 to 300°C (32 to 572°F)
 High Temp Alarm: 0 to 300°C (32 to 572°F)
 Low Temp Alarm: -50 to 300°C (-58 to 572°F)
 High Current Alarm: 0.5 to 100A
 Low Current Alarm: 0.5 to 100A
 High Current Trip: 0.5 to 100A
 Ground Fault Alarm: 0.01 to 1.0A
 Ground Fault Trip: 0.01 to 1.0A
 TraceCheck Interval: 1 to 24 hr.
 RTD Fail-safe: Heater On or Heater Off
 Master Override Input: On or Off
 Alarm Contacts: NO or NC for each contact
 Alarm Light: Alarm on, Alarm off, Flash during alarm then on, Flash during alarm then off
 GF Test: 1 to 24hrs, test now

Specifications subject to change without notice.

3.3.11 ML100 Dedicated Interface Module

Control Power

Power Requirements: From Control Module ML100 Interface connector: +5Vdc/0.1A, +8Vdc/0.4A, -6.5Vdc/1mA

Communications

Port: 1 Dedicated parallel connection
 Interconnect: 26-pin IDC ribbon cable
 Cable Length: 3 feet maximum

Environment

Approval: CSA NRTL/C
 Class 1, Div.II, Groups A,B,C,D
 Class 1, Zone-2, Groups IIC
 Operating Range: -40°C to +60°C
 Conformal Coating: Boards conformal coated for hostile environments

User Interface

Display: 20-character x 2-line VFD Alpha-numeric display
 Keypad: 9 tactile keys, polyester faceplate
 - Setpoint, measured, status
 - Message Up, Message Down
 - Value Up, Value Down
 - Reset
 - Store
 Contrast: Adjustable by potentiometer
 Panel Indicators: Power on
 Current heater display on
 Serial communication active
 System alarm
 Process alarm

Bezel

Material: 304 Stainless steel
 Mounting: For mounting on NEMA-12 or NEMA-4 enclosure door. Includes gasketing.
 Optional: 304 Stainless steel shroud with plexi-glass hinged cover to protect keypad from physical damage.

3.3.12 MR100 Group Interface Module

Control Power

Power Requirements: 12VA @ 120Vac, 50 or 60Hz

Communications

Ports: 1 Serial network connections
 Type: RS485
 Protocol: Modbus® RTU.
 Transmission Rate: 600, 1200, 2400, 4800, 9600 baud.
 Interconnect: 2-wire, shielded, twisted pair.
 Highway Distance: 4,000 feet without repeater.
 Modules per Highway: (1) MR100 and (30) Control Modules.

Environment

Approval: CSA NRTL/C
 Class1, Div.II, Groups A,B,C,D
 Class1 Zone 2, Group IIC
 Operating Range: -40°C to +60°C
 Conformal Coating: Boards conformal coated for hostile environments

Alarm

Alarm Output: Programmable for NO or NC contacts
 One DC opto-isolated contact
 One dry mechanical contact
 Alarm Output Rating:
 Hazardous Areas: DC contact: 30Vdc/0.1A, 500mW max
 Dry mech contact: 30Vdc@10mA max
 DC contact: 30Vdc/0.1A, 500mW max
 Dry mech contact: 120Vac@1.0A max
 Ordinary Areas:
 Alarm Light Output: LED Indicator: 12Vdc/30mA
 Alarm Messages: Refer to Control Module Specifications

User Interface

Display: 20-character x 2-line VFD Alpha-numeric display
 Keypad: 9 tactile keys, polyester faceplate
 - Setpoint, measured, status
 - Message Up, Message Down
 - Value Up, Value Down
 - Reset
 - Store
 Contrast: Adjustable by potentiometer
 Panel Indicators: Power on
 Current heater display on
 Serial communication active
 System alarm
 Process alarm

Bezel

Material: 304 Stainless steel
 Mounting: For mounting on NEMA-4/4X enclosure door. Includes gasketing.
 Optional: 304 Stainless steel shroud with plexi-glass hinged cover to protect keypad from physical damage.

Specifications subject to change without notice.

3.4 Model Codes for Control Panels

MasterTrace™ systems are available in different configurations depending on the application. The product model code

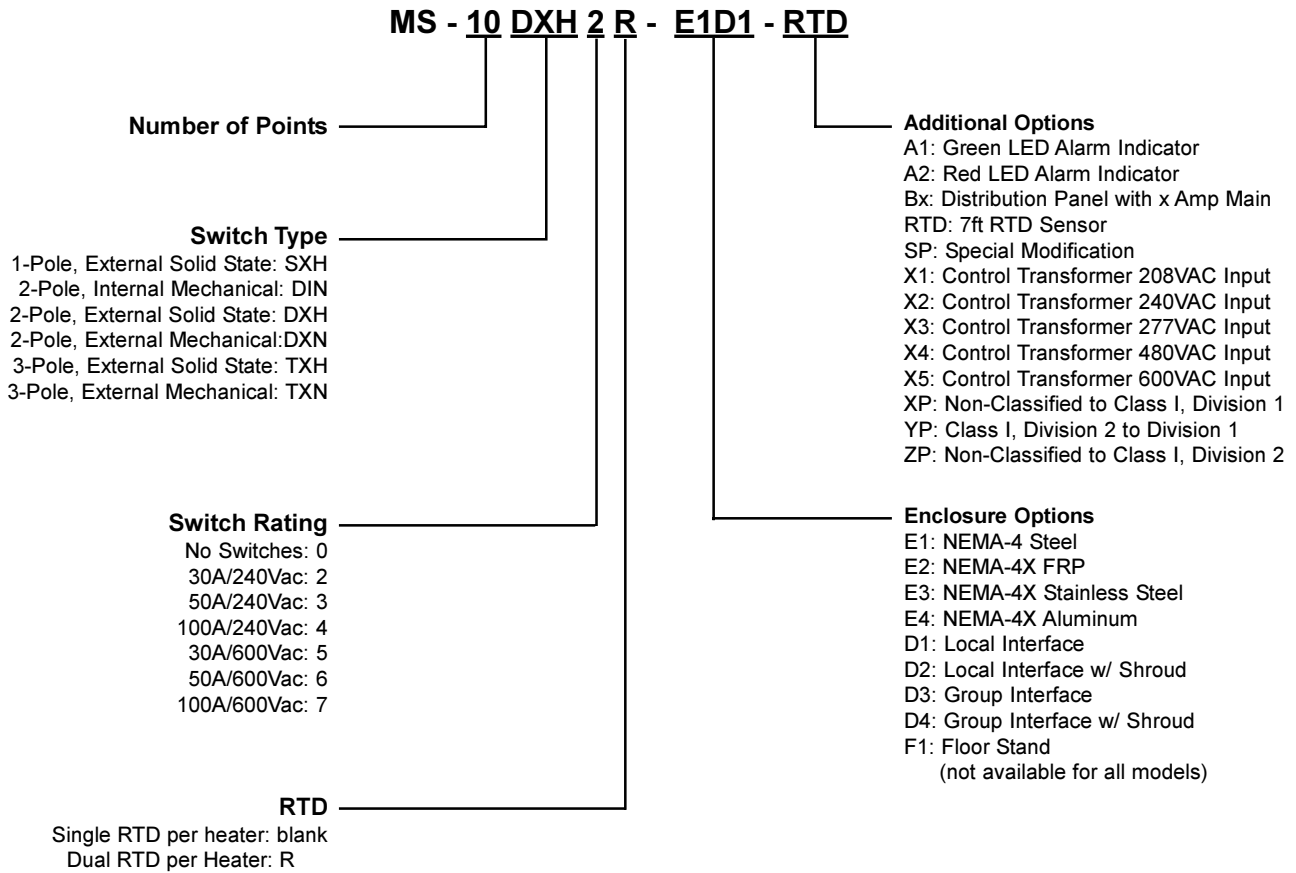

on the MasterTrace™ system identifies the features.
 For mixed module panel, add controller model suffix as required.

eg 1. MS-13DXH2-E1D3-RTD-SP
 Assumed: 1 MS-10ADXH0 MODULE
 1 MS-2DXH0 MODULE
 1 MS-1DXH0 MODULE

eg 2. MS-10DXH2-2DXH2R-E1D3-RTD-SP
 Assumed: 1 MS-10ADXH0 MODULE
 2 MS-1DXH0 MODULE

eg 3. MS-10DXH2-7TXH2R-1DXH2-E1D3-RTD-SP
 Assumed: 1 MS-10ADXH0 MODULE
 1 MS-5ATXH0 MODULE
 2 MS-1TXH0 MODULE
 1 MS-1DXH0 MODULE

4 Installation

4.1 Control Panel Mounting

Mount the control panel at a convenient location, generally with the Interface Module at eye level. Placing the Interface Module in direct sunlight may make reading the display difficult.

Cut holes and mount hubs at suitable locations in the enclosure as required. It is recommended that power wires are run in separate conduits from RTD and RS-485 signal wires.

4.2 RTD Sensor Wiring

RTD Sensors should be 3-wire, 100 W, platinum to DIN standard 43760. Mount the RTD element on the pipe, away from the heat trace and 30° to 45° from the bottom of the pipe. The total circuit resistance per conductor from the RTD to the control panel must be less than 10 ohm. Exceeding this resistance will result in non-linear temperature measurement. Beldon cable 8770 or equivalent will allow RTDs to be placed up to 1,000 feet from the control panel. Complete all RTD wiring according to the *Panel Layout Drawings* located in the control panel package.

The RTD sensor must be installed on the pipe surface or thermal well before the pipe insulation to ensure proper thermal contact. The RTD position should be 180° from the electric heat trace cable which is the coldest spot of the pipe. The RTD sensor may be secured to the pipe by fiber-glass tape. The RTD probe is delicate and should not be bent or used as a tool to puncture insulation. If additional wiring is required for the RTD, shielded 3-lead wire sized 18 or 20AWG must be used for the RTD sensor to minimize the effects of noise pickup. A typical RTD installation is shown in *Figure 4.1*.

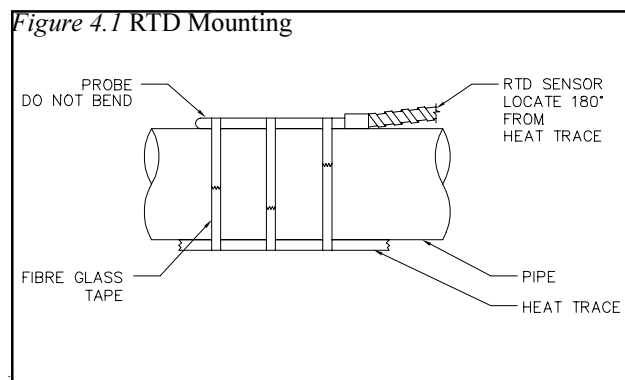

4.3 Ground Fault Protection

In order for the ground fault protection to be effective, a solid ground path must be provided for the heat trace. Electrical heat trace with a grounded outer braid or conductive sheath is recommended. For ground fault monitoring, each heater circuit ground must be individually returned. Ground fault protection is for equipment protection only, not personnel.

4.4 Ground Fault Testing

To test the ground fault monitoring function on 5 and 10 point modules, a ground fault test function is available. A 90mA ac current source is provided on terminals 120 and 121 where a wire loop is inserted through all ground CT's and terminated at the GF test terminals. The GF test wire loop is internally wired on internal mechanical switch models. See *Typical Wiring Diagram* in *Appendix D* for details.

4.5 Power and Heater Wiring

Complete all supply and load wiring for the heater circuits according to the *Typical Wiring Diagram*. Note that voltages may vary by circuit. Power wiring should be sized appropriately to the breaker size and maximum ambient operating temperatures. Control panels with breakers built-in will require a power feed size appropriately to the main breaker size.

Wire Size (AWG)	Current Load (A)	Max. Ambient Temperature (°C)
6	30	50
8	30	40
10	24	50
12	16	50



Wiring methods should comply with Canadian Electrical or National Electrical Code and local codes. Power and signal wires should not be run in the same conduit system. Wiring should be rated at least 90 °C. Wiring methods must conform to Class 1, Div.2 or Class 1, Zone 2 requirements.

4.6 Ground Connection

A dedicated ground wire must be connected to the ground lug or bar on the control panel. This provides a solid ground path in the event of a fault. The input transient

protectors on the modules can not provide the necessary protection without a solid ground.

4.7 Safety Ground

Each of the ten RTD inputs are protected by a transient suppressor network which acts as a barrier against transient energy pick-up by the RTD probe. In order for this protection to work effectively, terminals 122 and 123 must be terminated to a solid ground separate from the enclosure chassis ground. On panels pre-wired at the factory, transient ground is tied to earth ground so that it is not left open. It is recommended that transient ground be disconnected from enclosure ground and moved to a separate ground.

Note: The transient suppressor network is not an intrinsically safe barrier and is only available on 5 and 10 point models.

4.8 Control Power Wiring

The control panel requires control power supplied from a dedicated circuit breaker. The supply voltage for control power to the MasterTrace modules is 120VAC. If the supply voltage is incorrect, the modules may be damaged. Control power must be protected by a circuit breaker no larger than 15A. If the control panel includes a breaker panel, control power connection to a branch breaker will be already done at the factory. Recommended wire size for control power wiring is 14 AWG at maximum ambient temperature of 40°C and 12 AWG t maximum ambient temperature of 50°C.



Wiring methods should comply with Canadian Electrical or National Electrical Code and local codes. Power and signal wires should not be run in the same conduit system. Wiring should be rated at least 90 °C. Wiring methods must conform to Class 1, Div.2 or Class 1, Zone 2 requirements.

4.9 Alarm Wiring

MasterTrace controllers have two alarm contacts and one active alarm output for driving a LED alarm indicator. Both the alarm contacts are software configurable for normally open or closed. The alarm LED output is software configurable for alarm on, alarm off or flash during alarm. Refer to *typical wiring diagrams in Appendix D* for alarm output terminals.

The mechanical alarm output is rated 30Vdc, 0.1A in hazardous locations and 120Vac/1A in ordinary areas. The DC alarm output is an opto-isolated transition output

rated 30Vdc/100mA, 500mW max.

The alarm LED output is rated 12Vdc, 30mA. It can be used to drive a 12Vdc LED indicator. Alarm outputs are designed for interface to annunciator, panels, PLC or DCS.

4.9 Commissioning

Commissioning the MasterTrace™ Control Panel requires an understanding of its functions including how to display measured values and, if necessary, to change setpoints or configuration. Read *Chapter 5: Operation* and *Chapter 6: Programming & Setup* before proceeding if you are not familiar with the MasterTrace™ operation.

Once the wiring is complete and in accordance with the *Typical Wiring Diagram in Appendix D*, close the circuit breaker to provide control power to the panel.

On power-up, the Interface Module displays this sequence of messages:

MASTERTRACE HEAT
TRACING CONTROL

NEXTRON CORP
(403)735-9555

FIRMWARE VERSION:
REV. D1-02-01

MANUAL VERSION:
1501-0006_1

SELF TEST
PASSED

Refer to *Appendix C: Summary of Alarms and Causes*, if the Self Test Failure alarm light turns on or the Interface Module displays this message:

SELF TEST
FAILURE ALARM

4.9.1 Enter Program Changes: Refer to the Programming Sheet for Control Panel & Modules (Rev. D1). Refer to *Figure 4.1* for Sample Programming Worksheet. Ignoring the alarm messages and lights, enter all required user setup changes. The Program Enable dip switch/terminals on the Interface Module must be set to ENABLE to allow programming. Refer to *Figure 5.7* for the ML100 Dedicated Interface Module or *Figure 5.9* for the MR100 Group Interface Module. It is recommended that this dip switch be set to DISABLE or the terminals be jumpered to prevent unauthorized entry of program changes.

There are no consumable components contained in any of the models covered in this manual. There is no cleaning requirements for any of the models covered in this manual.

4.9.2 Turn On Heater Power: Close the circuit breakers for all heat trace circuits controlled by the MasterTrace™ control panel.

4.9.3 Respond to Alarm Conditions: Examine each alarm condition and correct problems as required. High Current and Low Temperature alarms should be ignored during start-up and until normal operating levels have been reached. Refer to *Appendix C: Summary of Alarms and Causes* for information on potential causes of alarms.

4.9.4 Check Actual Readings: Once the system has reached normal operating temperatures, check the individual temperature, current and ground fault current readings against expected values for each circuit. This can indicate wiring or design errors.

4.9.5 Check the RTD Wiring: Locate and open the junction box or head of the selected RTD. Either disconnect the RTD or short the wires. The RTD Short or RTD Open alarm will be displayed on the Interface Module showing the Heater Name. Confirm that the displayed heater matches the heater of the selected RTD.



Warning - Explosion Hazard - Substitution of components may impair suitability for Class 1, Division 2 or Class 1, Zone 2.



Warning - The ground fault trip function is intended for equipment protection only and should not be used in place of ground fault protection for personnel protection where this is required.



Warning - Explosion Hazard - Do not disconnect equipment unless power has been switched off or the area is known to be non-hazardous.

5 Operation

This section provides information on how to operate the MasterTrace™ modules. Refer to the module name plate(s) and *Chapter 3.4, Model Codes*, if you are unsure of your product and its specific features.

5.1 Control Modules

Refer to the following Figures for the appropriate Control Module(s).

- *Figure 5.1:* MS-1DIN2 & MS-2DIN2
- *Figure 5.2:* MS-1TXH0
- *Figure 5.3:* MS-1DXH0 & MS-2DXH0
- *Figure 5.4:* MS-5ADIN2 & MS-10ADIN2
- *Figure 5.5:* MS-5ADXH0, MS-5ATXH0 & MS-10ADXH0

5.1.1 Status Lights:

- **L1 Power:** Light is on when control power is present.
- **L2 Heater:** Each heater circuit has a light which is on when the heater relay or contactor is closed.
- **L3 Alarm:** Light is on if there are one or more alarms on any circuits of the Control Module.
- **L4 Address:** Light is on when Control Module is in Address Enable Mode. Light must be on to allow the Module Number to be changed from a master on the data highway.
- **L5 Transmit:** Each serial port has a light which flashes while the Control Module is transmitting information to the data highway.
- **L6 Receive:** Each serial port has a light which flashes while the Control Module is receiving information from the data highway.
- **L7 Override:** Light is on when the Override Input terminals are shorted. All heaters which are programmed with Master Override set to ON should be on when light is on.

5.1.2 Switches & Jumpers:

- **S1 Address Mode:** When the switch is set to DISABLE, the Module Number cannot be changed from a master on the data highway. When set to ENABLE, the Module Number can be changed for the next ten minutes from a master on the data highway. During this time the ADDRESS light is on.
- **S2 RS485-120:** When the jumper is set to IN, the RS-485 line is terminated by a 120 ohm resistor. Only the last Control Module on the data highway should be set to IN.

5.1.3 Terminals: Refer to *Typical Wiring Diagrams* for

power, heater and RTD field connections.

Note: Not all models are equipped with the following.

- **T1 Alarm Contacts:** Alarm contact type is the same for all models. In hazardous areas the opto-isolated dc output is rated 30 Vdc @ 0.1 A (terminals 4 and 5) and the dry mechanical output is rated 30Vdc@10mA (terminals 6 and 7). In ordinary areas the opto-isolated dc output is rated the same as hazardous but the dry mechanical output is rated 120 Vac@1A. Contacts are configurable for normally open or closed.
- **T2 Alarm Light Output:** The output is configurable for normally open, closed or flash. Output is rated 12 Vdc @ 30 mA for an LED type lamp (MS-1 & MS-2 terminals 16+ and 17-, MS-5A and MS-10A terminals 13+ and 14-).
- **T3 Master Override Input:** Only those heaters which are programmed with Master Override set to ON are affected by the Master Override Input. When the terminals are open, all Master Override Enabled heaters are forced off. When the terminals are closed, all Master Override Enabled heaters are controlled by their individual RTDs unless their Heater Setpoint is set to OFF. In this case, the heater is turned on. The logic of this input allows either ambient temperature override or load shedding on all or selected heaters. (MS-1 & MS-2 terminals 26+ and 27-, MS-5A and MS-10A terminals 11+ and 12-).
- **T4 RTD Input:** 3 wire RTD input. Ground terminal connects to shield or case. Lead resistance compensated. (MS-1 & MS-2 terminals 8-15, MS-5A and MS-10A terminals 60-99).
- **T5 Control Power Input:** 120Vac input, 2A fused (terminals 2 and 3), earth ground (terminal 1).
- **T6 CT's:** Heater Current and Ground Fault monitoring transformers (MS-1 & MS-2 terminals 28-35, MS-5A and MS-10A terminals 20-59). Solid-state models only.
- **T7 SSR's:** 12Vdc, 15mA max for driving digital input of solid state relays (MS-1 & MS-2 terminals 40-43, MS-5A and MS-10A terminals 100-119). Solid-state models only.
- **T8 Voltage:** Connect to heater input for voltage monitoring. 300Vac max. (MS-1 & MS-2 terminals 36-39). One and two-point single-phase solid-state models only.
- **T9 Safety Ground:** Terminate to solid ground separate from panel ground for transient protection circuit on RTD inputs. (MS-5A and MS-10A terminals 122 and 123). Five and ten-point models only.

- **T10 GF Test:** Wire loop is passed through GF CT's and terminated at the GF test terminals. An ac test current is applied through wire loop during GF testing. (MS-5A and MS-10A terminals 120 and 121). Five and ten-point models only.
- **T11 Address Enable Open:** When the terminals are shorted, the Module Number cannot be changed from a master on the data highway. (MS-1 & MS-2 terminals 24 and 25). One and two-point models only.
- **T12 Heater Power Input:** 280Vac max input voltage. (MS-1 & MS-2 terminals 28, 29, 32 and 33, MS-5A and MS-10A terminals 20-39). Mechanical models only.
- **T13 Heater Power Output:** 280Vac/30A max continuous (MS-1A & MS-2A terminals 30, 31, 34 and 35, MS-5A and MS-10A terminals 40-59). Mechanical models only.

5.1.4. Communications Ports:

- **C1 ML100 Interface:** Standard connection to a Dedicated Interface Module via a ribbon cable. Maximum cable length is five feet.
- **C2 Serial Port 1:** Standard connection to an RS-485 data highway via a 2-conductor, shielded, twisted pair cable. Maximum Cable length with 30 Control Modules without repeater is 4,000 feet. (MS-1 & MS-2 terminals 18+, 19-, 20 SHD, MS-5A and MS-10A terminals 8+, 9-, 10 SHD)
- **C3 Serial Port 2:** Standard connection to a second RS-485 data highway via a 2-conductor, shielded, twisted pair cable. Maximum Cable length with 30 Control Modules without repeater is 4,000 feet. (MS-1 & MS-2 terminals 21+, 22-, 23 SHD, MS-5A and MS-10A terminals 17+, 18-, 19 SHD)

Figure 5.1 MS-1DIN2 & MS-2DIN2 Control Modules

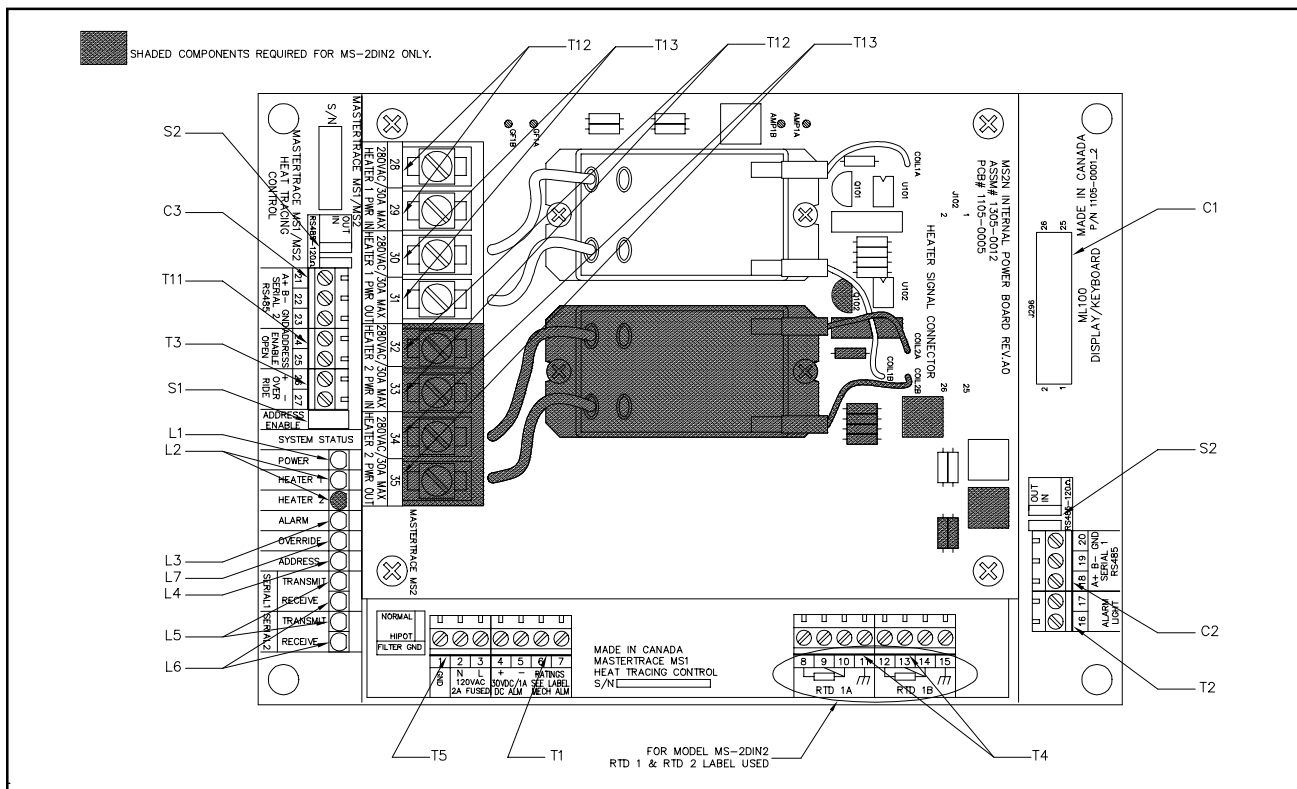

Figure 5.4 MS-5ADXH0, MS-5ATXH0 & MS-10ADXH0 Control Modules

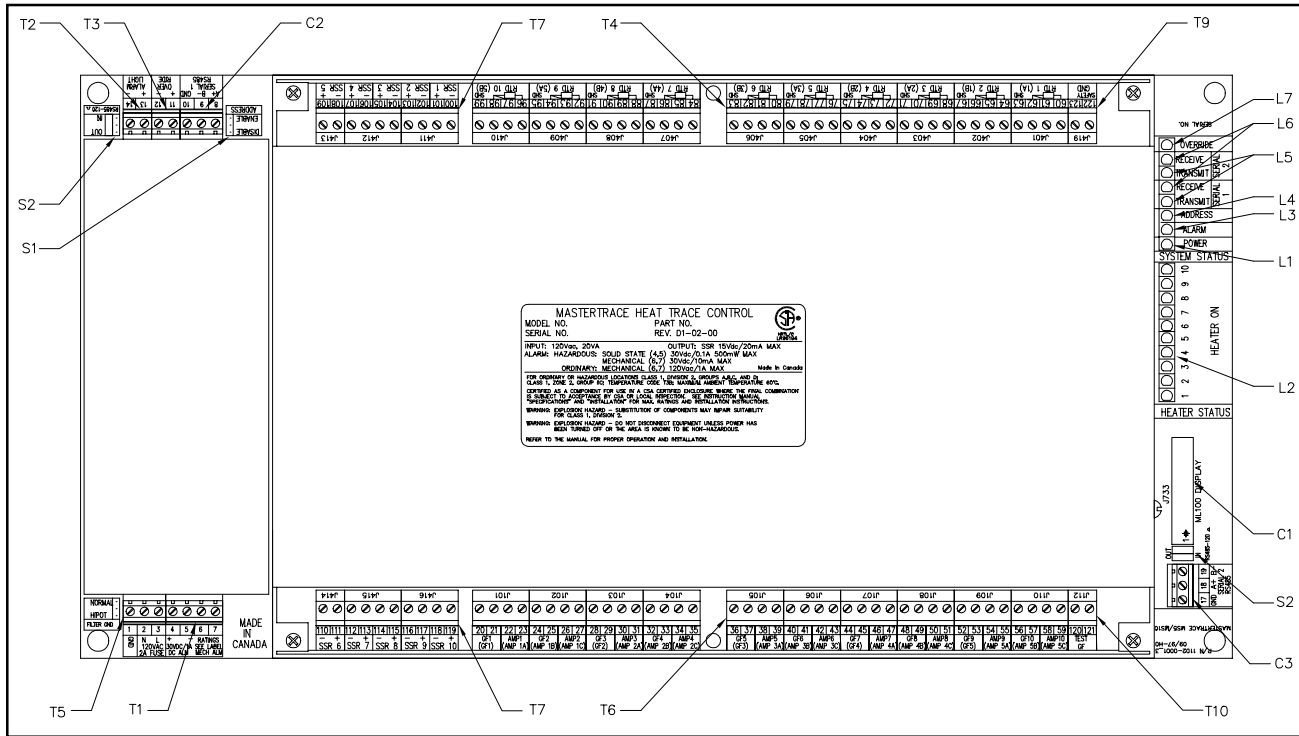
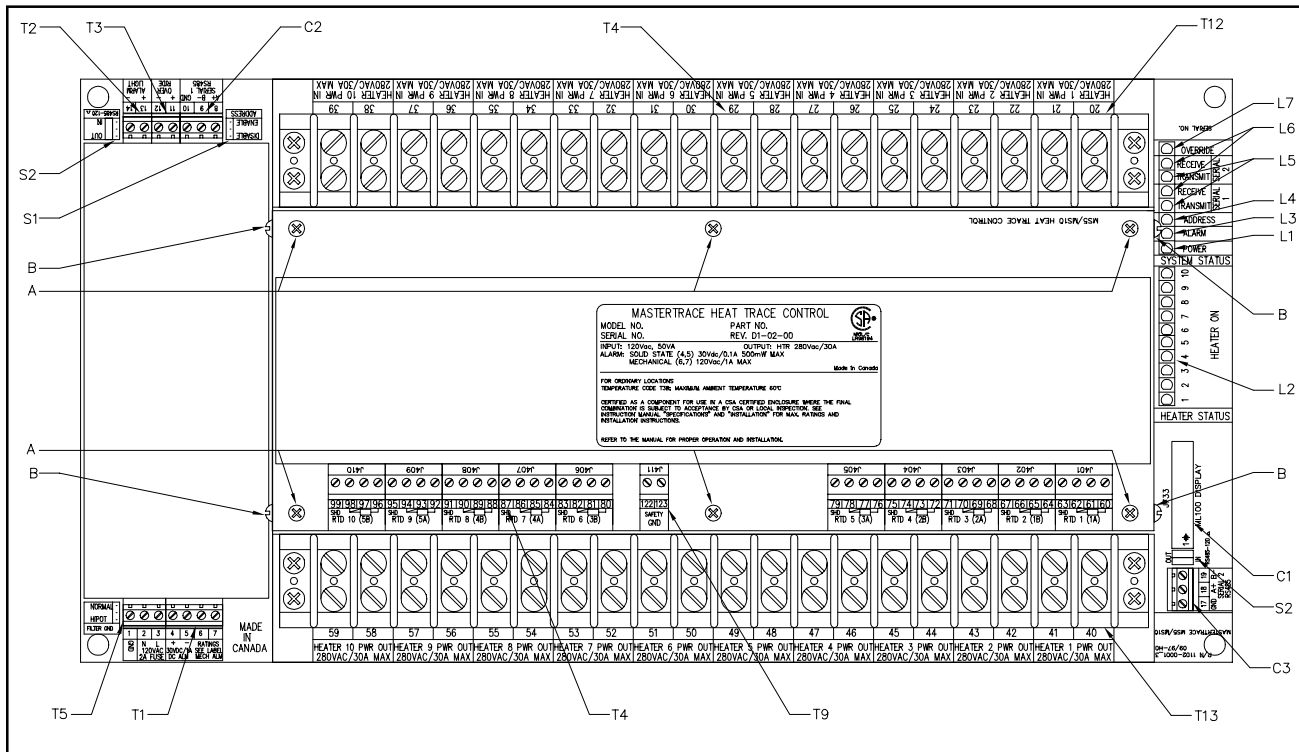

Figure 5.5 MS-5ADIN2 & MS-10ADIN2 Control Module



5.2 Interface Modules

The ML100 Dedicated Interface Module is capable of programming and monitoring one Control Module such as the MS-10A. It is a “Dedicated” interface because it connects to only one Control Module. It is designed to be door-mounted in a NEMA-4 enclosure in an industrial environment. Operator interface is through the Status Indicators, LCD Display and the Keypad. Refer to *Figure 5-6* and *Figure 5-7*.

The MR100 Group Interface Module is capable of programming and monitoring from one to thirty Control Modules. It is a “Group” interface because it connects, via a serial cable to several Control Modules. It is designed to be door-mounted in a NEMA-4 enclosure in an industrial environment. Operator interface is through the Status Indicators, LCD Display and the Keypad. Refer to *Figure 5-6* and *Figure 5-8*.

5.2.1 Status Lights Located on Circuit Board :

- **L8** Transmit: LED flashes when the Interface Module is transmitting information to the data highway. MR100 only.
- **L9** Receive: LED flashes when the Interface Module is receiving information from the data highway. MR100 only.

5.2.2 Switches and Jumpers:

- **S3** Program Enable: When the Program Enable dip switch is set to DISABLE, programming is disabled and setpoints and configuration cannot be changed. Otherwise, programming is allowed.

5.2.3 Terminals: Refer to the *Typical Wiring Diagrams* for power field connections.

- **T14** Alarm Contacts: In hazardous areas the dc output is rated 30 Vdc @ 0.1 A (terminals 906 and 907) and the dry mechanical output is rated 30Vdc@10mA (terminals 904 and 905). In ordinary areas the dc output is rated the same as hazardous but the dry mechanical output is rated 120 Vac@1A. Contacts are configurable for normally open or closed. MR100 only.
- **T15** Alarm Light Output: The output is configurable or normally open, closed or flash. Output is rated 12 Vdc @ 30 mA for an LED type lamp (terminals 909+ and 908-). MR100 only.
- **T16** Control Power Input: 120Vac input (terminals 902 and 903), earth ground (terminal 901). MR100 only.
- **T17** Program Enable: When shorted, programming is disabled; setpoints and configuration cannot be changed. When open, programming is allowed. (MR100 terminals 913 and 914)

5.2.4 Communications Port:

- **C4** Parallel Port: Standard connection to a single Control Module via a ribbon cable. Maximum cable length is five feet. ML100 only.
- **C5** Serial Port : Standard connection to an RS-485 data highway via a 2-conductor, shielded, twisted pair cable. Maximum Cable length with 30 Control Modules without repeater is 4,000 feet. (terminals 912+, 911-, 910 SHD). MR100 only.

5.2.5 Trim Potentiometers:

- **P1** LCD display: Adjusts the contrast according to the viewing angle.

5.2.6 Status Lights Located on Faceplate :

- **L10** Power: The green Power light should be on at all times indicating that control power is applied to the Interface Module. If the light is off either there is no voltage across terminals 902 and 903 or the Interface Module has a malfunction and requires servicing.
- **L11** Heater: The green Heater light is on if the selected heater is energized.
- **L12** Communicate: Random flashing of the green Communicate light indicates that serial communications are active on the Control Module to which it is connected.
- **L13** System Fail: The red System Fail light should be off, indicating that the system check was successful. On the Dedicated Interface Module, if the light is on, the Control Module has failed its self-test and requires servicing. On the Group Interface Module, if the light is on, the Group Interface Module has failed its self-test and requires servicing.
- **L14** Alarm: The red alarm light is off when there are no alarms. The light will flash if any alarm conditions are present. Press [STATUS] to view alarms.

5.2.7 Alphanumeric Display:

- **D1** Display: Two lines with sixteen alphanumeric characters per line. It is backlit for viewing in low-light conditions.

5.2.8 Keypad:

- **K1** Interface Module Keypad: Consists of nine keys which, when used in connection with the Alphanumeric Display, allow complete control of programming and monitoring of any Control Module connected to the Interface Module.

The [SETPOINT] key provides entry to the Setpoint Menu which allows the user to program and test all connected Control Modules.

The Setpoint Menu is arranged in four columns. Quickly

pressing [SETPOINT] twice accesses the top of the second column; pressing three times accesses the top of the third column, and so on.

The [MEASURED] key provides entry to the Measured Values Menu which allows the user to display the measured values for all connected Control Modules. The Measured Values Menu is arranged in three columns. Quickly pressing [MEASURED] twice accesses the top of the second column; pressing three times accesses the top of the third column.

The [STATUS] key provides immediate access to the System Status Menu which displays the alarm status for all connected Control Modules and allows access to individual alarm details.

The [MESSAGE ↑] key allows the user to move up through the selected menu.

The [MESSAGE ↓] key allows the user to move down through the selected menu.

The [VALUE ↑] key allows the user to increase the value of the displayed selected item.

The [VALUE ↓] key allows the user to decrease the value of the displayed selected item.

The [STORE] key allows the user to save the changed value of the selected item.

The [RESET] key allows the user to clear alarms that are no longer active.

5.2.9 Heater Numbering: Each heater is identified by a

number of the form “M-H”, where “M” is the Module Number and “H” is the local heater number. Ten-point Control Modules have local heater numbers from “1” through “10”. Each Control Module on the same data highway must have a unique Module Number.

5.2.10 Example: Display the Heater Control Temperature for Heater 3-2

Press [MEASURED] to enter the Measured Values Menu as shown:

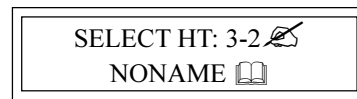
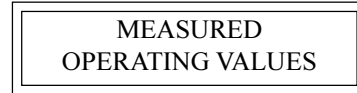

Press [VALUE ↑] or [VALUE ↓] to select Heater 3-2.

Press [STORE].

Press [MESSAGE ↓] until the desired value is displayed as shown:



Figure 5.6 ML100 & MR100 Interface Modules, Front View

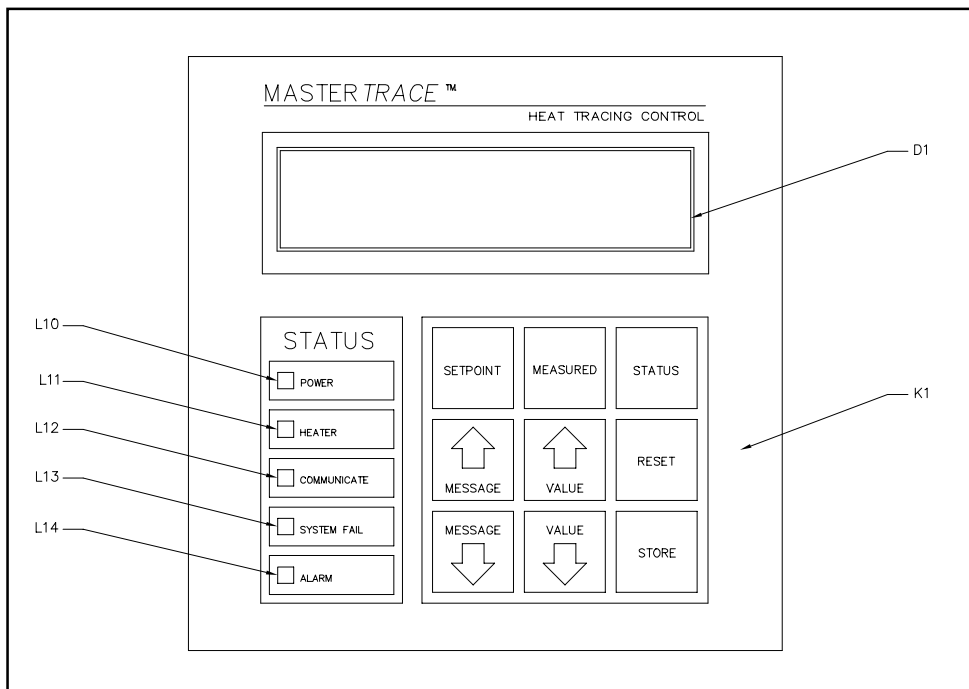

Figure 5.7 ML100 Dedicated Interface Modules, Rear View

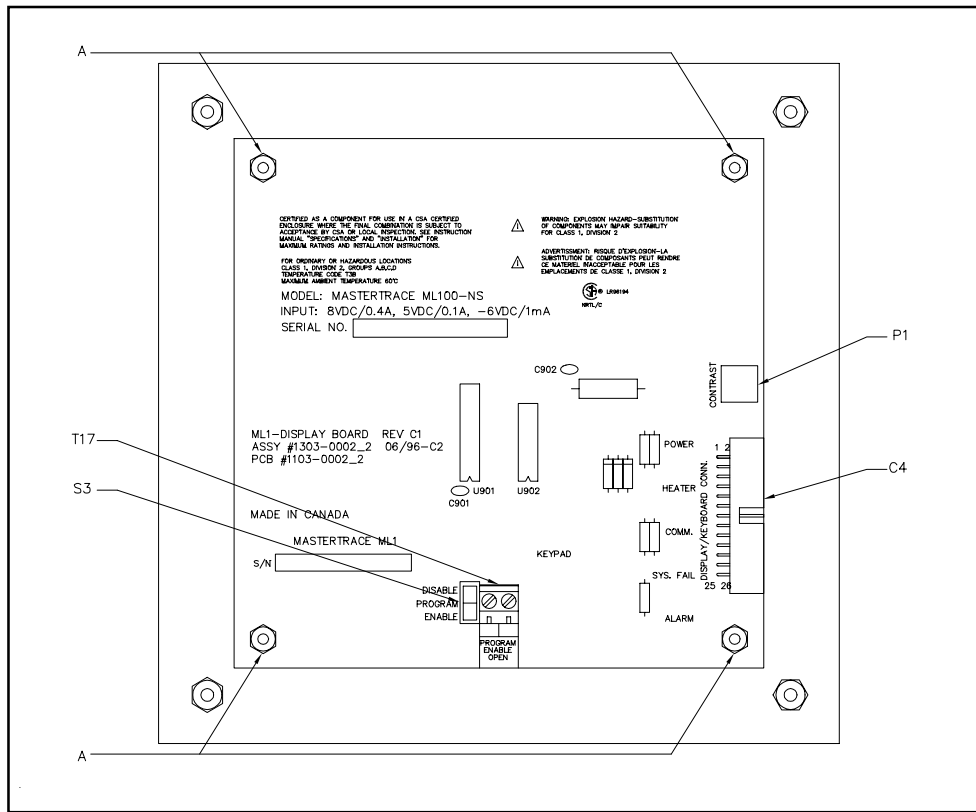

Figure 5.8 MR100 Group Interface Modules, Rear View

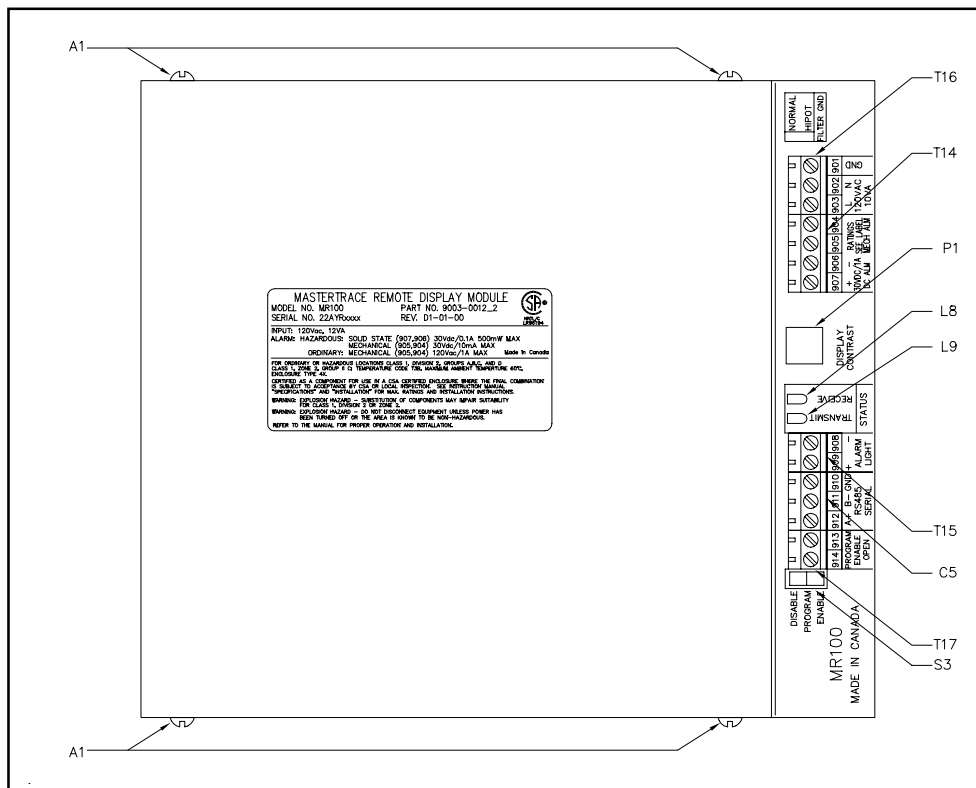
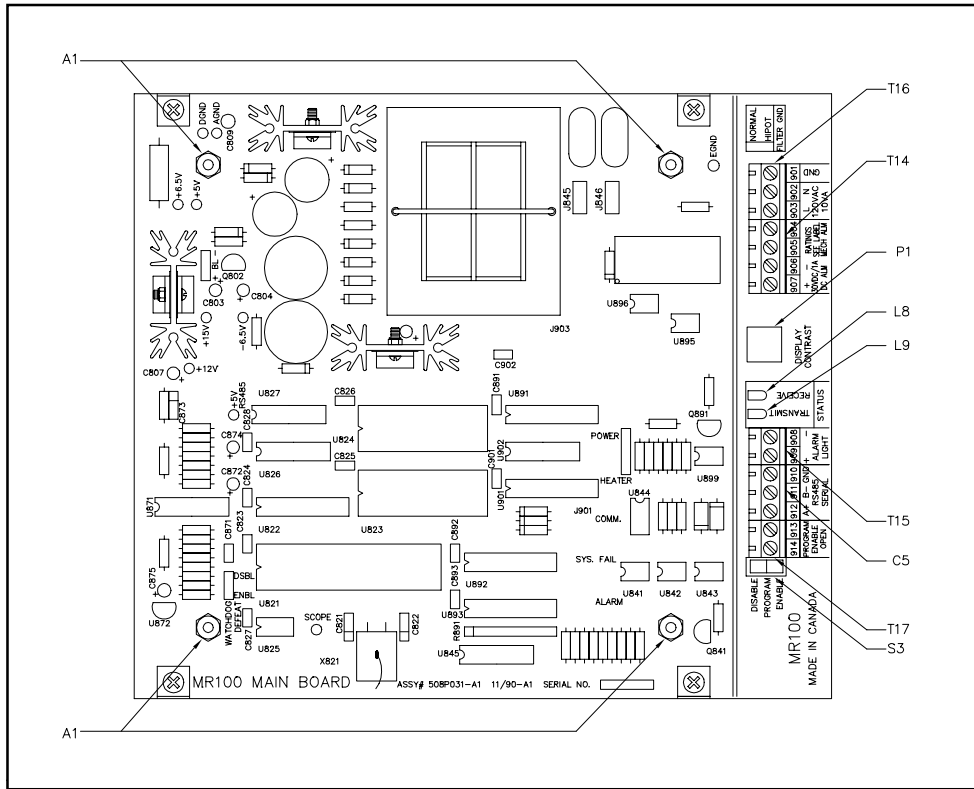

Figure 5.9 MR100 Group Interface Module, Cover Removed



5.3 Responding to Alarms

The [STATUS] key provides immediate access to the System Status Menu which displays the alarm status for all connected Control Modules. If the Default Display is programmed to System Status, the System Status Menu will automatically be displayed after a period of time equal to the Display Timeout has expired from last key press.

If there are no alarms, this message is displayed:



If there are one or more alarms, this message is displayed:



Pressing [MESSAGE ↓] displays the alarm detail screens for each alarm as shown:

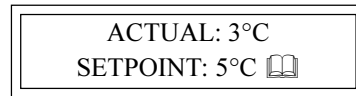

The first screen shows what the alarm is, the second shows where the alarm is and the third screen shows why there is an alarm. The Scan Time determines the rate at which these screens are displayed.

If there no more alarms, this message is displayed:



Refer to *Appendix C: Summary of Alarms and Causes* for information on reasons for the alarms. After the cause of each alarm has been corrected, any non-latching alarm will clear. Latching alarms (All Trip and TraceCheck™

alarms) must be reset to clear the alarm. To reset the alarm, first

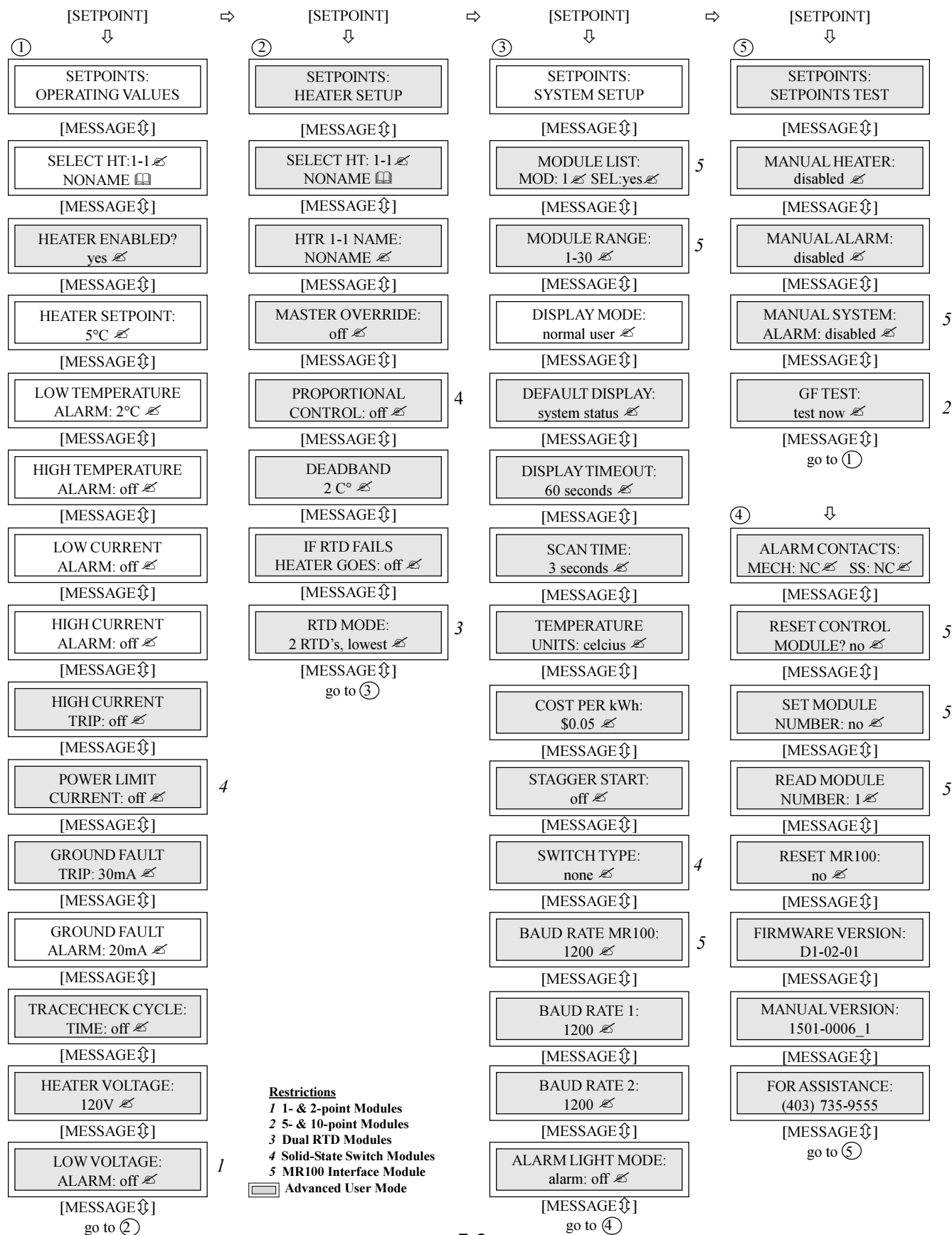

5.5 Setpoint Values Menu: Three-Phase Modules (1- and 5-point only)

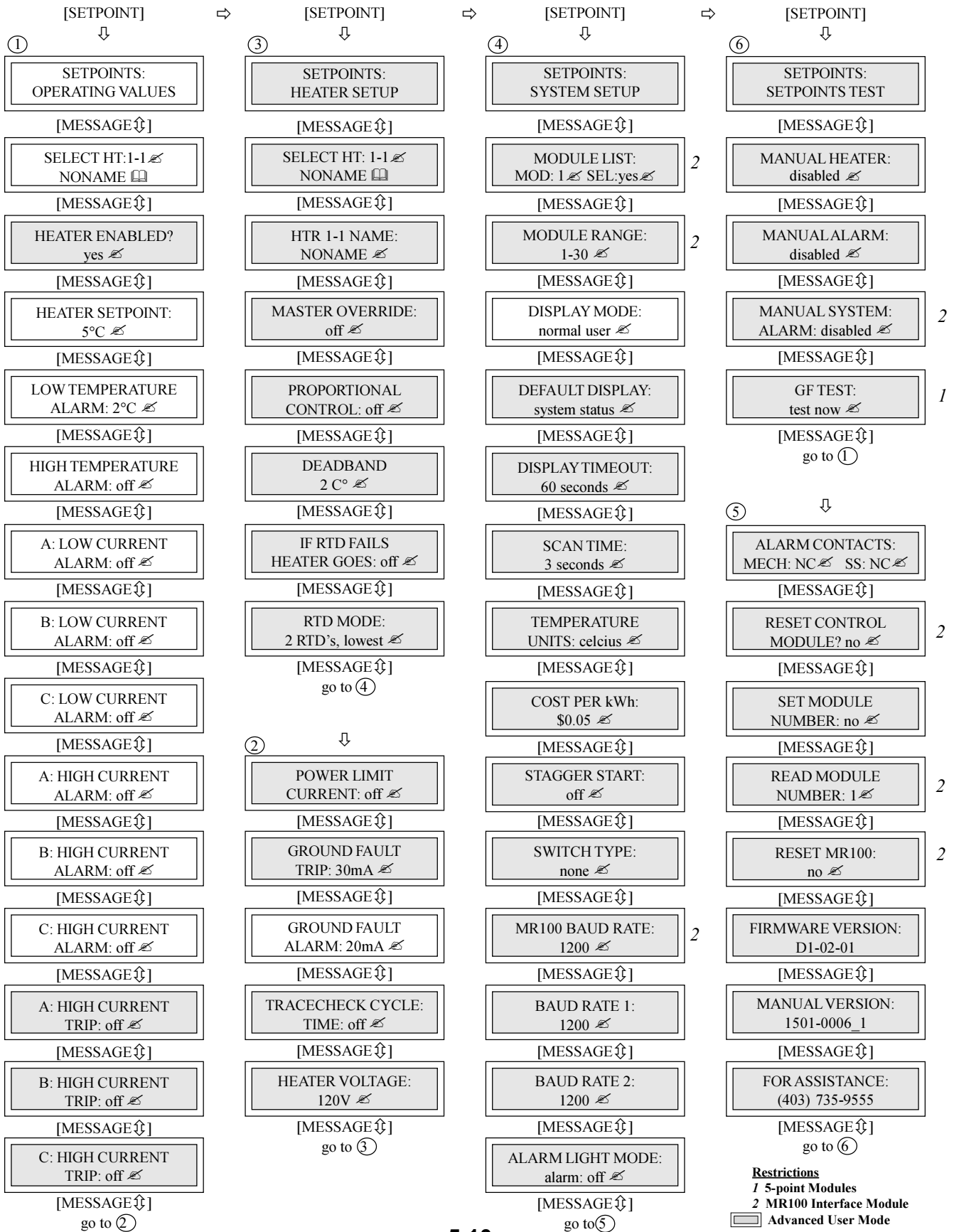

5.6 Measured Values Menu: Single-Phase Modules

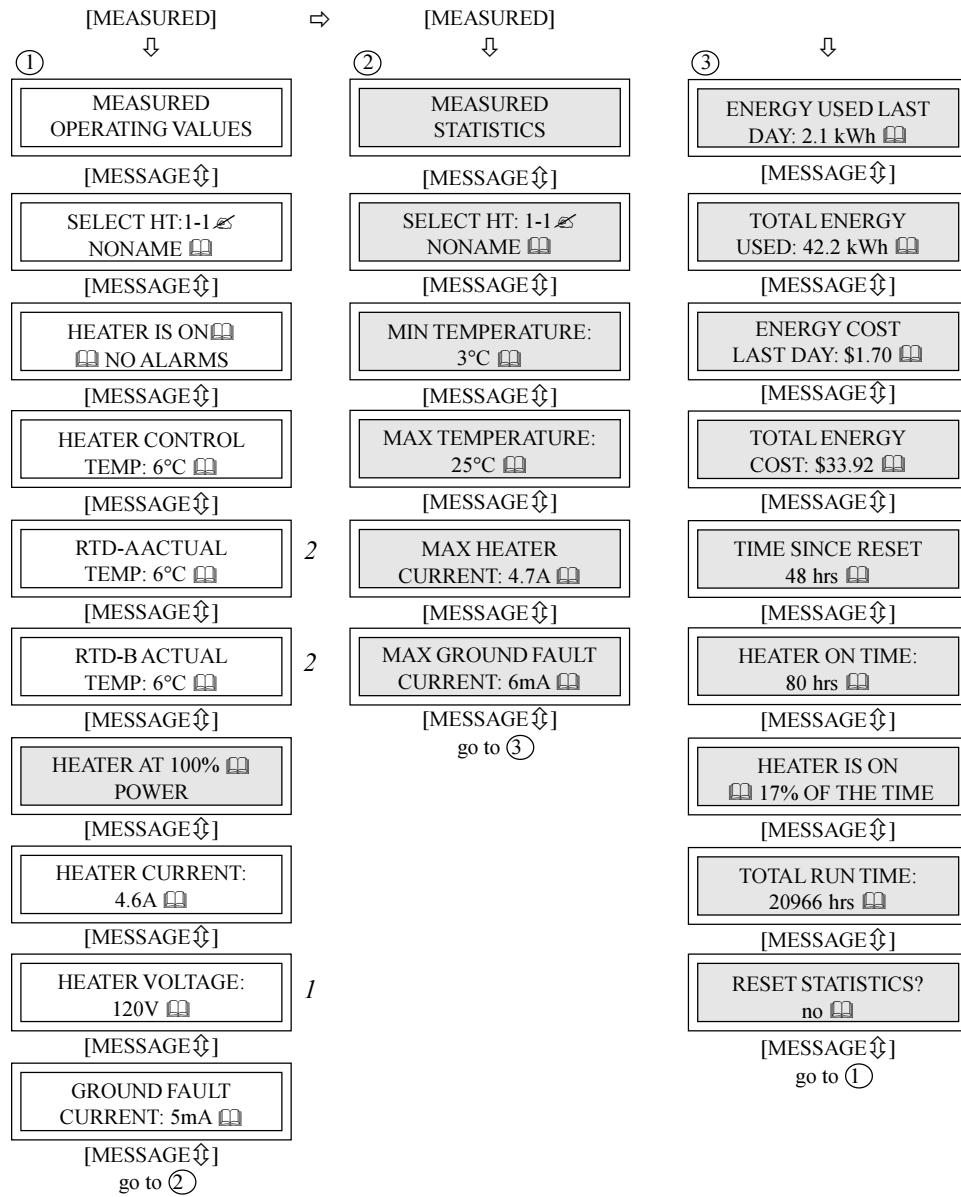

Restrictions
 1 1- & 2-point Modules
 2 Dual RTD Modules
 [Advanced User Mode Icon] Advanced User Mode

5.7 Measured Values Menu: Three-Phase Modules

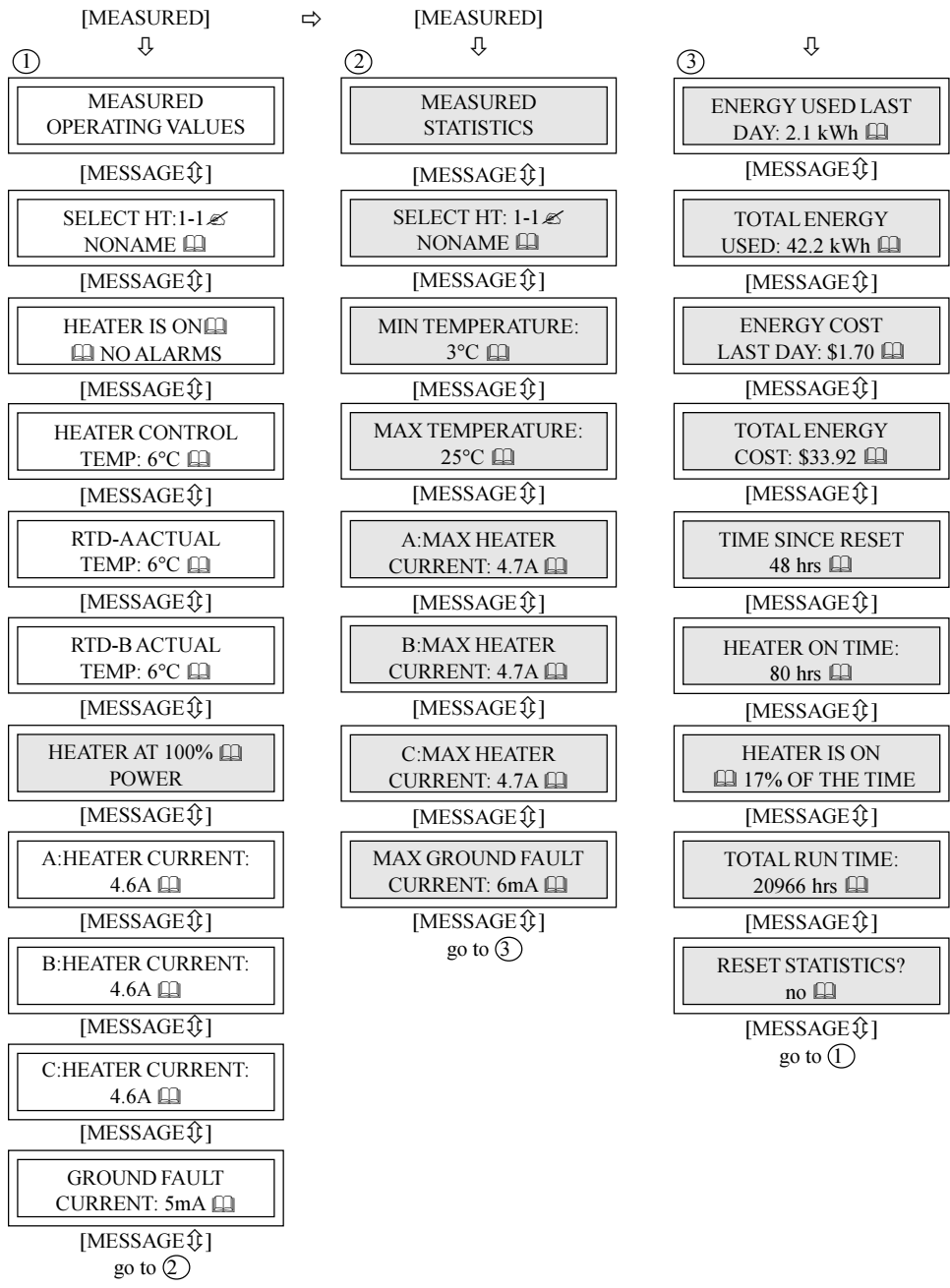

Restrictions
 Advanced User Mode

6 Programming & Setup

6.1 Getting Started

Refer to the Programming Sheet for Control Panel or Modules (Rev. D1) provided with the control panel or see *Figure 4.1* Sample Programming Worksheet. It shows the options available for your Control Modules and the values entered at the factory. Enter all changes to the factory setup under “User Setup” prior to entering the changes through the Interface Module. Increase the value in the DISPLAY TIMEOUT function (msg. S3-06) so that programming is not disrupted by the display switching to the default. *Chapters 5.4 and 5.5* show the Setpoint Values Menu. A detailed description of messages is shown in *Appendix A*.

6.2 Program Enable

Each Interface Module is provided with a programming interlock to prevent tampering with setpoints. Programming must be enabled for any values to be stored. Refer to *Chapter 2.3.1*.

If the programming is disabled and [STORE] is pressed, this message is displayed:

NOT STORED
PROG DISABLED

6.3 Module List (MR100 Group Interface)

The MODULE LIST function (msg. S3-02) identifies all the Control Modules that pole or communicate with the MR100 Interface Module. Each Control Module must be “Selected” for the MR100 to communicate with it. Any Control Module not selected will be skipped by the SELECT HT functions (msg. M1-02, M2-02, S1-02 & S2-02). Note that a Control Module can still be fully functional without communicating with an Interface Module.

6.4 Heater Enable

The HEATER ENABLED function (msg. S1-03) identifies which heater circuits to control and monitor. Any heater circuit that is “Disabled” will not have any control or monitoring and will be skipped by the SELECT HT function.

6.5 Example: Change the Setpoint for Heater 3-2 to 50 °C

Press [SETPOINT] to enter the Setpoint Menu. This message is displayed:

SEPOINTS:
OPERATING VALUES

SELECT HT: 3-2 
NONAME 

Press [VALUE ↑] or [VALUE ↓] to select heater 3-2. Press [STORE].

Press [MESSAGE ↓] until the desired message is displayed as shown:

HEATER SETPOINT:
55°C 

Press [VALUE ↑] or [VALUE ↓] until desired temperature is displayed (50 °C). Press [STORE].

If the value was successfully stored in the Control Module, this message is displayed:

SETPOINT:
STORED

7 Networking Modules

7.1 RS-485 Communications

The MasterTrace™ System uses RS-485 for all serial communications. RS-485 provides for one master (MR100 Group or Computer Interface) and several slaves (Control Modules) on one data highway. The

MasterTrace™ Control Modules expand this limitation by the use of two serial ports. This allows a Control Module to connect to two different data highways and therefore to two masters. The Central Computer Interface has one port per data highway, allowing communication to an unlimited number of Control Modules. Refer to the MasterTrace™ MC100 Operator's Manual. Figure 7.1 indicates how the Control Modules and Interface Modules can be networked.

Figure 7.1 MASTERTRACE System Network

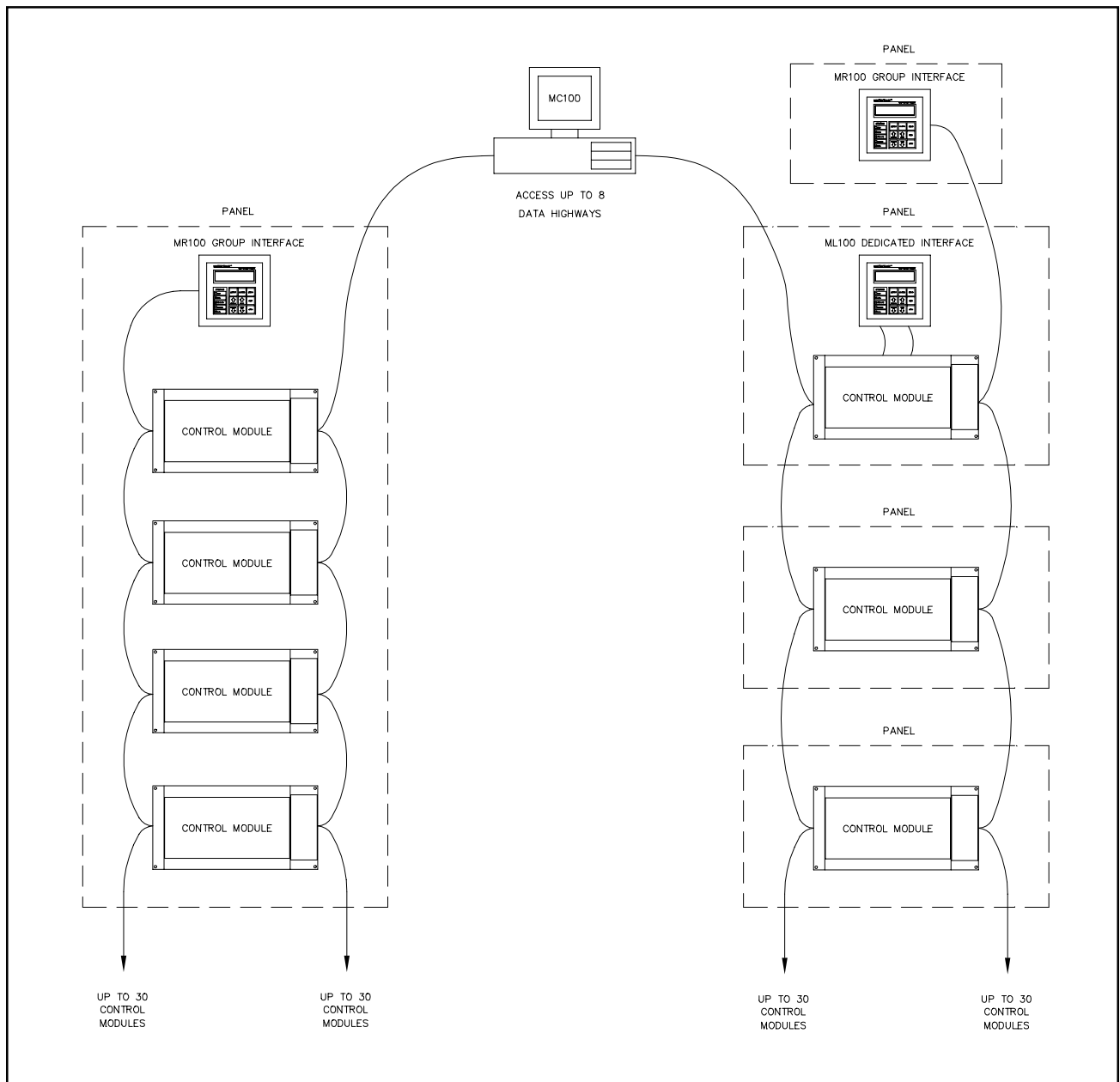

7.2 RS-485 Wiring

Beldon cable 9841 or equivalent is recommended for the RS-485 connection. It is a 2-wire, shielded, twisted pair. From the serial port of the Interface Module, the cable is connected to a serial port on each Control Module in daisy-chain fashion. The total length of this daisy-chain should not exceed 4,000 feet. A repeater can be used to exceed this length or to create a “T” connection. The last Control Module on the daisy-chain must be terminated. To terminate the serial port, set the RS485-120 Jumper to the IN position. The RS-485 communications circuitry is opto-isolated from the control circuitry. Do not externally ground the shield. Refer to the figure for the appropriate Module.

7.3 Removing a Control Module from the Network

7.3.1. Remove from the Module List: From the Central Computer or Group Interface on the data highway, access the MODULE LIST function (msg. S3-02), find the Module Number to be removed and change the select setting to NO.

7.3.2 Disconnect from the Data Highway: Remove the RS-485 cable from the serial port of the Control Module. If the Control Module was at the end of the data highway, change the RS485-120 jumper setting on the new end-of-line Control Module to the IN position.

7.3.3 Repeat for Second Data Highway: Repeat the above if the Control Module was connected to a second data highway.

7.4 Adding a Control Module to the Network

7.4.1 Connect to the Data Highway: Connect the Control Module to the existing data highway by daisy-chaining RS-485 cable to serial port number one. Note that only the last Control Module on the data highway should have its RS485-120 jumper set to IN.

7.4.2 Check the Module Number: Check the Programming Sheet for Control Panel or Modules that came with the new Control Module for the Module Number. It must be a unique number for the data highways to which the Control Module connects. If the Module Number is unique then proceed to Enabling the Module. Otherwise, change the Module Number as follows.

7.4.3 Change the Module Number: Choose a unique

Module Number for the Control Module. The MODULE LIST function (msg. S3-02) displays which Module Numbers have not been selected. Use the SET MODULE NUMBER function (msg. S3-17), to give the Control Module a new, unique number. Note that the new Control Module, and no other, must be in the Address Enable Mode. The Address Enable light is on when the Control Module is in Address Enable Mode. Refer to *Chapter 5.1.2*.

7.4.4 Add to the Module List: From the Central Computer or Group Interface on the data highway, access the MODULE LIST function (msg. S3-02), find the Module Number of the Control Module to be added and change the select setting to YES.

7.4.5 Program the Module: Set the HEATER ENABLE function (msg. S1-03) setting to YES for each circuit that is used on the Control Module, then enter the setpoints and configuration as required.

7.4.6 Repeat for Second Data Highway: Each Control Module can connect to two data highways. To connect to a second data highway, repeat the above steps except for assigning the module number.

7.5 Communication With Third Party Equipment

MasterTrace™ controls communicate using Modbus RTU communication protocol. To communicate with MasterTrace™ using a third party master, a Modbus driver must be available and the MasterTrace™ Modbus registers must be programmed into the master. The Modbus registers and data structure is available from the factory upon request. Programming the Modbus registers and software to extract data from the registers should be done by someone familiar with the third party equipment.

7.6 Baud Rate

The communication baud rate determines how fast data is sent along the data highway. Baud rates available are 600, 1200, 2400, 4800 and 9600 bits per second. The default baud rate is 1200. Each device on the network must be set at the same baud rate in order to communicate. The user may increase the baud rate but noise immunity, with long cable lengths, is reduced. When changing baud rate through an MR100 display, change the baud rate of each control module connected to the data highway first and the MR100 last. Be sure to select the correct serial port on the control module.

8 Service & Testing

8.1 Troubleshooting Hints

8.1.1 Disable Advanced Functions: When you are trying to determine the problem on a heater circuit it can be helpful to turn off the advanced functions for the heater circuit or control module being checked. These include PROPORTIONAL CONTROL (msg. S2-05), POWER LIMIT CURRENT (msg. S1-19), TRACECHECK™ CYCLE (msg. S1-22) and STAGGER START (msg. S3-10).

8.1.2 Use MANUAL HEATER Function: It may be necessary to force the heater circuit on to take measurements. The MANUAL HEATER function (msg. S4-02) is provided for this purpose and eliminates the need to change the heater setpoint to force the heater circuit on.

8.2 Field Tests

8.2.1 RTD Input Test: The RTD input can be tested by connecting a known resistance of sufficient accuracy. A decade Resistance Box or RTD Simulator is recommended. Disconnect the RTD(s) from the control module ensuring that the leads are adequately labeled. Connect the Resistance Box as shown in Figure 8.3. If the module has dual RTD inputs, set the RTD MODE function (msg. S2-08) to “2 RTDs, averaged” and connect the second RTD input in parallel with the first as shown. Select a temperature from Figure 8.1 or Figure 8.2 that is close to the maintain temperature and set the Resistance Box to the equivalent resistance. The displayed HEATER CONTROL TEMPERATURE (msg. M1-04) should equal the selected temperature within the accuracy of the devices used. If there is a significant discrepancy, return the Control Module to the factory for repair. When testing is complete, reconnect the RTD(s).

8.2.2 Current Input Test: The current inputs can be tested by using an ammeter. A clamp-on CT is recommended to eliminate the need to disconnect the heater leads. To measure phase current, place the clamp-on CT around a single heater phase wire. For three-phase loads, this means around three phase conductors and a neutral (for 4-wire systems). Using the Interface Module, display the current being measured. The displayed current should equal the measured current within the accuracy of the devices used. If there is a significant discrepancy, return the Control Module to the factory for calibration.

8.2.3 Alarm Output Test: If an external alarm signal is integral to the system operation, the alarm output should be tested regularly. The alarm output on each control module is tested using the MANUAL ALARM function (msg. S4-03). The alarm output on the MR100 Interface Module is tested using the MANUAL SYSTEM ALARM

Figure 8.1 Resistance versus Temperature in °C (DIN 43760 RTD)

°C	R (ohms)	°C	R (ohms)	°C	R (ohms)
-40	84.27	80	130.89	200	175.84
-30	88.22	90	134.70	210	179.51
-20	92.16	100	138.50	220	183.17
-10	96.09	110	142.29	230	186.82
0	100.00	120	146.06	240	190.46
10	103.90	130	149.82	250	194.08
20	107.79	140	153.58	260	197.69
30	111.67	150	157.32	270	201.30
40	115.64	160	161.04	280	204.88
50	119.39	170	164.76	290	208.46
60	123.24	180	168.47	300	212.03
70	127.07	190	172.16		

Figure 8.2 Resistance versus Temperature in °F (DIN 43760 RTD)

°F	R (ohms)	°F	R (ohms)	°F	R (ohms)
-40	84.27	160	127.50	360	169.29
-30	86.47	170	129.62	370	171.34
-20	88.66	180	131.74	380	173.39
-10	90.85	190	133.86	390	175.43
0	93.03	200	135.97	400	177.48
10	95.22	210	138.08	410	179.51
20	97.39	220	140.18	420	181.55
30	99.57	230	142.29	430	183.58
40	101.74	240	144.38	440	185.61
50	103.90	250	146.48	450	187.63
60	106.06	260	148.57	460	189.65
70	108.22	270	150.66	470	191.67
80	110.38	280	152.74	480	193.68
90	112.53	290	154.82	490	195.69
100	114.68	300	156.90	500	197.69
110	116.83	310	158.97		
120	118.97	320	161.04		
130	121.10	330	163.11		
140	123.24	340	165.17		
150	125.37	350	167.23		

Figure 8.3 RTD Input Test

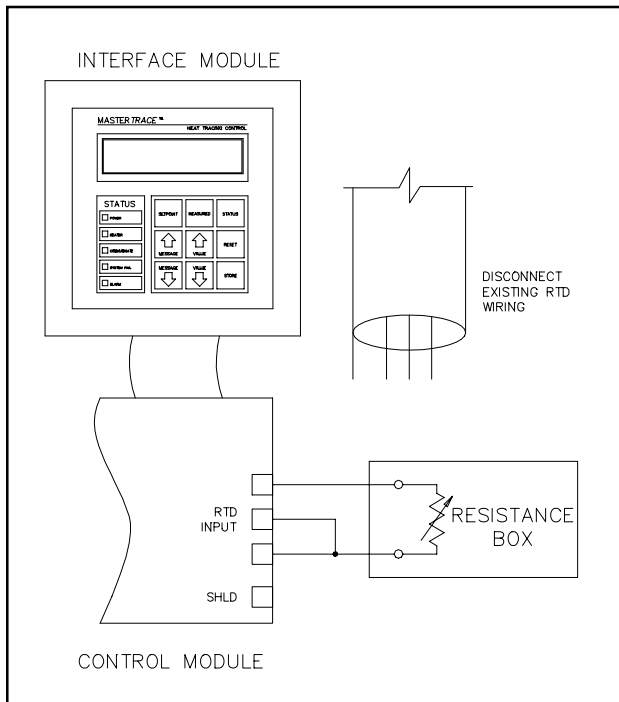

function (msg. S4-04).

8.3 Field Repairs

8.3.1 Replacing a Switch on MS-1DIN2 & MS-2DIN2 Modules: These modules use mechanical relays mounted inside the Control Module. Refer to *Figure 5.1* in completing the following steps.

Turn off power to the Control Module and all affected heater circuits.

- Locate the failed relay and remove the six quick disconnects.
- Remove the two #6-32 screws that secure the relay and remove the failed relay.
- Use Nextron part number 0403-0002 (Potter & Brumfield # T92S7A22-120) for replacement relay.
- Repeat above steps in reverse order to assemble.

8.3.2 Replacing a Switch on MS-5ADIN2 & MS-10ADIN2 Module: These modules use mechanical relays mounted inside the Control Module. Refer to *Figure 5.5* in completing the following steps.

- Turn off power to the Control Module and all affected heater circuits.
- Remove the six #6-32 machine screws (labeled “A”) from the RTD board.
- Lift off the RTD board and disconnect the ribbon cable from the RTD board. The RTD connections do not need to be removed.
- Remove the four #6-32 machine screws (labeled “B”)

that hold the Power Board housing and remove the housing.

- Locate the failed relay and remove the six quick disconnects.
- Remove the top #6-32 screw and Nylock nut that secure the relay and remove the failed relay.
- Use Nextron part number 0403-0002 (Potter & Brumfield # T92S7A22-120) for replacement relay.
- Repeat above steps in reverse order to assemble.

8.3.3 Replacing a Switch on a Module with SXH, DXH or TXH Switch Types: These modules use solid-state relays mounted external to the Control Module. Complete the following steps.

- Turn off power to the affected heater circuits.
- Locate the failed relay and disconnect the wires (ensure that all wires are adequately labeled).
- Remove the two #6-32 screws that secure the relay, remove the failed relay and discard the thermal conductive pad.
- Use Nextron part number 1007-0003 (Berquist # Q2-101) for replacement thermal conductive pad. Refer to the *Typical Layout Drawing* for the part number of the replacement relay.
- Repeat above steps in reverse order to assemble.

8.3.4 Replacing a Switch on a Module with DXN or TXN Switch Types: These modules use mechanical contactors mounted external to the Control Module. Complete the following steps.

- Turn off power to the affected heater circuits.
- Locate the failed contactor and disconnect the wires (ensure that all wires are adequately labeled).
- Remove the four screws that secure the contactor and remove the failed contactor.
- Refer to the *Typical Layout Drawing* for the part number of the replacement contactor.
- Repeat above steps in reverse order to assemble.

8.3.5 Replacing a DIN Switch Type Module: Before proceeding, check that all wires connected to the module are correctly labeled. Check that the Programming Sheet for Control Panel or Modules correctly reflects the configuration of the module. The replacement Control Module can be programmed before it is placed in the control panel by connecting a 120 Vac supply to its power input terminals and following the steps in *Chapter 6*. Complete the following steps.

- Turn off power to the Control Module and all affected heater circuits.
- Disconnect all wires to the Control Module. Refer to *Figure 5.1* or *Figure 5.5* as appropriate.

- Remove the four Nylock nuts that secure the Control Module to the back plate and remove the module.
- Repeat the above steps in reverse order to install the new module.
- If the new module has not been programmed according to the Programming Sheet for Control Panel or Modules, then complete at this time following the steps in *Chapter 6*.

8.3.6 Replacing an MS-1 or MS-2 External Switching Module: Before proceeding, check that all wires connected to the module are correctly labeled. Check that the Programming Sheet for Control Panel or Modules correctly reflects the configuration of the module. The replacement control module can be programmed before it is placed in the control panel by connecting a 120 Vac supply to its power input terminals and following the steps in *Chapter 6*. Complete the following steps.

- Turn off power to the Control Module and all affected heater circuits.
- Disconnect all wires to the Control Module. Refer to *Figure 5.2* or *Figure 5.3*.
- Remove the four Nylock nuts that secure the Control Module to the back plate and remove the module.
- Repeat the above steps in reverse order to install the new module.
- If the new module has not been programmed according to the Programming Sheet for Control Panel or Modules, then complete at this time following the steps in *Chapter 6*.

8.3.7 Replacing an MS-5 or MS-10 Module with External Switching: Before proceeding, check that all wires connected to the module are correctly labeled. Check that the Programming Sheet for Control Panel or Modules correctly reflects the configuration of the module. The replacement control module can be programmed before it is placed in the control panel by connecting a 120 Vac supply to its power input terminals and following the steps in *Chapter 6*.

Complete the following steps.

- Turn off power to the Control Module and all affected heater circuits.
- Disconnect all wires from the Control Module. Refer to *Figure 5.4*.
- Remove the four Nylock nuts that secure the Control Module to the back plate and remove the module.
- Repeat the above steps in reverse order to install the new module.
- If the new module has not been programmed according to the Programming Sheet for Control Panel or Modules, then complete at this time following the steps in *Chapter 6*.

8.3.8 Replacing the ML100 Dedicated Interface Circuit Board Assembly or Keypad: Before proceeding, check that all wires connected to the module are correctly labeled. Complete the following steps.

- Turn off power to the Control Module which is connected to the ML100.
- Disconnect the ribbon cable from the Interface Module.
- Remove the four Nylock nuts, labeled “A” in *Figure 5.7* that secure the Interface Circuit Board Assembly.
- Disconnect the ribbon cable connector to the Keypad and remove the Interface Circuit Board Assembly.
- Replace the ML100 Dedicated Interface Circuit Board Assembly with Nextron part number 1303-0002_2.
- To replace the Interface Keypad, insert a small blade screwdriver between the bezel and a corner of the keypad as shown in *Figure 5.6*. Pry the Keypad up and pull off. Clean any residual adhesive with a solvent. Replace with Nextron part number 1002-0001. Remove the adhesive backing from the Keypad, insert the ribbon cable through the slot and press the Keypad into place.
- Repeat the above steps in reverse order to complete the installation.

8.3.9 Replacing an MR100 Group Interface Circuit Board Assembly or Keypad: Before proceeding, check that all wires connected to the module are correctly labeled. Check that the Programming Sheet for Control Panel or Modules correctly reflects the selected modules. Complete the following steps.

- Turn off power to the Interface Module.
- Disconnect all wires from the Interface Module.
- Remove the four #6-32 machine screws, labeled “A” in *Figure 5.8* that secure the Interface Module housing and remove the housing.
- Remove the four Nylock nuts, labeled “B” in *Figure 5.9* that secure the Interface Circuit Board Assembly.
- Disconnect the ribbon cable connector to the Keypad and remove the Interface Circuit Board Assembly.
- To replace the MR100 Group Interface Circuit Board Assembly use Nextron part number 1304-0001_1.
- To replace the Interface Keypad, insert a small blade screwdriver between the bezel and a corner of the keypad as shown in *Figure 5.6*. Pry the Keypad up and pull off. Clean any residual adhesive with a solvent. Replace with Nextron part number 1002-0001. Remove the backing from the Keypad, insert the ribbon cable through the slot and press the Keypad into place.
- Repeat the above steps in reverse order to complete the installation.
- Program the selected Control Modules for communications.

B: LOW CURRENT
ALARM: 10.5A 

MESSAGE NO: S1-09 APPLIES TO: Selected Heater
 DEFAULT VALUE: off VALUE RANGE: 0.5 to 100.0 A, off
 DISPLAY MODE: All RESTRICTIONS: Three-Phase Modules

This function sets the phase “B” Low Current Alarm setpoint. *It must be less than the phase “B” High Current Alarm setpoint.* To disable this alarm set the value to “off”. When the Heater Current-B is less than or equal to this setpoint, the Low Current-B Alarm is activated and a “LOW CURRENT-B ALARM” message is added to the System Status messages. The alarm deactivates when the Heater Current-B rises above this alarm setpoint. The value range is in 0.5 A increments. *Note: This setpoint is based on the heater at 100% power. If Proportional Control or Power Limit is enabled, all current measurements will be converted to 100% power, based on a constant resistive load, before being compared to the alarm setpoint.*

C: LOW CURRENT
ALARM: 10.5A 

MESSAGE NO: S1-10 APPLIES TO: Selected Heater
 DEFAULT VALUE: off VALUE RANGE: 0.5 to 100.0 A, off
 DISPLAY MODE: All RESTRICTIONS: Three-Phase Modules

This function sets the phase “C” Low Current Alarm setpoint. *It must be less than the phase “C” High Current Alarm setpoint.* To disable this alarm set the value to “off”. When the Heater Current-C is less than or equal to this setpoint, the Low Current-C Alarm is activated and a “LOW CURRENT-C ALARM” message is added to the System Status messages. The alarm deactivates when the Heater Current-C rises above this alarm setpoint. The value range is in 0.5 A increments. *Note: This setpoint is based on the heater at 100% power. If Proportional Control or Power Limit is enabled, all current measurements will be converted to 100% power, based on a constant resistive load, before being compared to the alarm setpoint.*

HIGH CURRENT
ALARM: 15.0A 

MESSAGE NO: S1-11 APPLIES TO: Selected Heater
 DEFAULT VALUE: off VALUE RANGE: 0.5 to 100.0 A, off
 DISPLAY MODE: All RESTRICTIONS: Single-Phase Modules

This function sets the High Current Alarm setpoint. *It must be greater than the Low Current Alarm setpoint.* To disable this alarm set the value to “off”. When the Heater Current is greater than or equal to this setpoint, the High Current Alarm is activated and a “HIGH CURRENT ALARM” message is added to the System Status messages. The alarm deactivates when the Heater Current falls below this alarm setpoint. The value range is in 0.5 A increments. The maximum value for internal switching Control Modules is 30 A. *Note: This setpoint is based on the heater at 100% power. If Proportional Control or Power Limit is enabled, all current measurements will be converted to 100% power, based on a constant resistive load, before being compared to the alarm setpoint. Converted currents at low duty cycles will experience round off errors. High current alarm settings may need to be extended to prevent erroneous alarms at low duty cycles.*

MASTERTRACE

A: HIGH CURRENT
ALARM: 15.0A 

MESSAGE NO: S1-12 APPLIES TO: Selected Heater
DEFAULT VALUE: off VALUE RANGE: 0.5 to 100.0 A, off
DISPLAY MODE: All RESTRICTIONS: Three-Phase Modules

This function sets the phase “A” High Current Alarm setpoint. *It must be greater than the Low Current-A Alarm setpoint.* To disable this alarm set the value to “off”. When the Heater Current-A is greater than or equal to this setpoint, the High Current-A Alarm is activated and a “HIGH CURRENT-A ALARM” message is added to the System Status messages. The alarm deactivates when the Heater Current-A falls below this alarm setpoint. The value range is in 0.5 A increments. *Note: This setpoint is based on the heater at 100% power. If Proportional Control or Power Limit is enabled, all current measurements will be converted to 100% power, based on a constant resistive load, before being compared to the alarm setpoint. Converted currents at low duty cycles will experience round off errors. High current alarm settings may need to be extended to prevent erroneous alarms at low duty cycles.*

B: HIGH CURRENT
ALARM: 15.0A 

MESSAGE NO: S1-13 APPLIES TO: Selected Heater
DEFAULT VALUE: off VALUE RANGE: 0.5 to 100.0 A, off
DISPLAY MODE: All RESTRICTIONS: Three-Phase Modules

This function sets the phase “B” High Current Alarm setpoint. *It must be greater than the Low Current-B Alarm setpoint.* To disable this alarm set the value to “off”. When the Heater Current-B is greater than or equal to this setpoint, the High Current-B Alarm is activated and a “HIGH CURRENT-B ALARM” message is added to the System Status messages. The alarm deactivates when the Heater Current-B falls below this alarm setpoint. The value range is in 0.5 A increments. *Note: This setpoint is based on the heater at 100% power. If Proportional Control or Power Limit is enabled, all current measurements will be converted to 100% power, based on a constant resistive load, before being compared to the alarm setpoint. Converted currents at low duty cycles will experience round off errors. High current alarm settings may need to be extended to prevent erroneous alarms at low duty cycles.*

C: HIGH CURRENT
ALARM: 15.0A 

MESSAGE NO: S1-14 APPLIES TO: Selected Heater
DEFAULT VALUE: off VALUE RANGE: 0.5 to 100.0 A, off
DISPLAY MODE: All RESTRICTIONS: Three-Phase Modules

This function sets the phase “C” High Current Alarm setpoint. *It must be greater than the Low Current-C Alarm setpoint.* To disable this alarm set the value to “off”. When the Heater Current-C is greater than or equal to this setpoint, the High Current-C Alarm is activated and a “HIGH CURRENT-C ALARM” message is added to the System Status messages. The alarm deactivates when the Heater Current-C falls below this alarm setpoint. The value range is in 0.5 A increments. *Note: This setpoint is based on the heater at 100% power. If Proportional Control or Power Limit is enabled, all current measurements will be converted to 100% power, based on a constant resistive load, before being compared to the alarm setpoint. Converted currents at low duty cycles will experience round off errors. High current alarm settings may need to be extended to prevent erroneous alarms at low duty cycles.*

HIGH CURRENT
TRIP: off 

MESSAGE NO: S1-15 APPLIES TO: Selected Heater
 DEFAULT VALUE: off VALUE RANGE: 0.5 to 100.0 A, off
 DISPLAY MODE: Advanced RESTRICTIONS: Single-Phase Modules
 This function sets the High Current Trip setpoint. *It must be greater than the Low Current Alarm and the High Current Alarm setpoints.* To disable this trip function set the value to “off”. When the Heater Current is greater than or equal to this setpoint, the heater circuit is opened, a High Current Trip Alarm is activated and a “HIGH CURRENT TRIP” message is added to the System Status messages. This is a latching alarm. When the cause of the alarm has been corrected, locate the alarm message in the Status Menu and press [RESET]. The value range is in 0.5 A increments. The maximum value for internal switching Control Modules is 30 A.
Note: This setpoint is based on the heater at 100% power. If Proportional Control or Power Limit is enabled, all current measurements will be converted to 100% power, based on a constant resistive load, before being compared to the alarm setpoint.

A: HIGH CURRENT
TRIP: off 

MESSAGE NO: S1-16 APPLIES TO: Selected Heater
 DEFAULT VALUE: off VALUE RANGE: 0.5 to 100.0 A, off
 DISPLAY MODE: Advanced RESTRICTIONS: Three-Phase Modules
 This function sets the phase “A” High Current Trip setpoint. *It must be greater than the Low Current-A Alarm and the High Current-A Alarm setpoints.* To disable this trip function set the value to “off”. When the Heater Current-A is greater than or equal to this setpoint, the heater circuit is opened, a High Current-A Trip Alarm is activated and a “HIGH CURRENT-A TRIP” message is added to the System Status messages. This is a latching alarm. When the cause of the alarm has been corrected, locate the alarm message in the Status Menu and press [RESET]. The value range is in 0.5 A increments.
Note: This setpoint is based on the heater at 100% power. If Proportional Control or Power Limit is enabled, all current measurements will be converted to 100% power, based on a constant resistive load, before being compared to the alarm setpoint.

B: HIGH CURRENT
TRIP: off 

MESSAGE NO: S1-17 APPLIES TO: Selected Heater
 DEFAULT VALUE: off VALUE RANGE: 0.5 to 100.0 A, off
 DISPLAY MODE: Advanced RESTRICTIONS: Three-Phase Modules
 This function sets the phase “B” High Current Trip setpoint. *It must be greater than the Low Current-B Alarm and the High Current-B Alarm setpoints.* To disable this trip function set the value to “off”. When the Heater Current-B is greater than or equal to this setpoint, the heater circuit is opened, a High Current-B Trip Alarm is activated and a “HIGH CURRENT-B TRIP” message is added to the System Status messages. This is a latching alarm. When the cause of the alarm has been corrected, locate the alarm message in the Status Menu and press [RESET]. The value range is in 0.5 A increments.
Note: This setpoint is based on the heater at 100% power. If Proportional Control or Power Limit is enabled, all current measurements will be converted to 100% power, based on a constant resistive load, before being compared to the alarm setpoint.

MASTERTRACE

C: HIGH CURRENT
TRIP: off 

MESSAGE NO: S1-18 APPLIES TO: Selected Heater
DEFAULT VALUE: off VALUE RANGE: 0.5 to 100.0 A, off
DISPLAY MODE: Advanced RESTRICTIONS: Three-Phase Modules Only

This function sets the phase “C” High Current Trip setpoint. *It must be greater than the Low Current-C Alarm and the High Current-C Alarm setpoints.* To disable this trip function set the value to “off”. When the Heater Current-C is greater than or equal to this setpoint, the heater circuit is opened, a High Current-C Trip Alarm is activated and a “HIGH CURRENT-C TRIP” message is added to the System Status messages. This is a latching alarm. When the cause of the alarm has been corrected, locate the alarm message in the Status Menu and press [RESET]. The value range is in 0.5 A increments.

Note: This setpoint is based on the heater at 100% power. If Proportional Control or Power Limit is enabled, all current measurements will be converted to 100% power, based on a constant resistive load, before being compared to the alarm setpoint.

POWER LIMIT CURRENT:
20.5A 

MESSAGE NO: S1-19 APPLIES TO: Selected Heater
DEFAULT VALUE: off VALUE RANGE: 0.5 to 100.0 A, off
DISPLAY MODE: Advanced RESTRICTIONS: Solid-State Modules Only

This function sets the maximum average current that flows in the heater circuit. It is useful for limiting the inrush current of self regulating cable or to reducing the power output of constant wattage heaters. Set the value below the breaker rating or to the maximum power desired (Wattage = Heater Voltage x Power Limit value). The value range is in 0.5 A increments. The maximum value for internal switching Control Modules is 30 A.

GROUND FAULT
TRIP: 100mA 

MESSAGE NO: S1-20 APPLIES TO: Selected Heater
DEFAULT VALUE: 50 mA VALUE RANGE: 10 to 1000 mA, off
DISPLAY MODE: Advanced RESTRICTIONS: None

This function sets the Ground Fault Trip setpoint. *It must be greater than the Ground Fault Alarm setpoint.* To disable this trip alarm set the value to “off”. When the Ground Fault Current is greater than or equal to this setpoint, the heater circuit is opened, the Ground Fault Trip Alarm is activated and a “GROUND FAULT TRIP” message is added to the System Status messages. This is a latching alarm. When the cause of the alarm has been corrected, locate the alarm message in the Status Menu and press [RESET]. The value range is in 5 mA increments.

GROUND FAULT
ALARM: 20mA 

MESSAGE NO: S1-21 APPLIES TO: Selected Heater
DEFAULT VALUE: 25 mA VALUE RANGE: 10 to 1000 mA, off
DISPLAY MODE: All RESTRICTIONS: None

This function sets the Ground Fault Alarm setpoint. *It must be less than the Ground Fault Trip setpoint.* To disable this alarm set the value to “off”. When the Ground Fault Current is greater than or equal to this setpoint, the Ground Fault Alarm is activated and a “GROUND FAULT ALARM” message is added to the System Status messages. The alarm deactivates when the Ground Fault Current falls below this alarm setpoint. The value range is in 5 mA increments.

TRACECHECK CYCLE
TIME: 4 hours 

MESSAGE NO: S1-22 APPLIES TO: Selected Heater
 DEFAULT VALUE: off VALUE RANGE: 1 to 24 hours, off
 DISPLAY MODE: Advanced RESTRICTIONS: None

This function sets the frequency at which TraceCheck™ is activated. TraceCheck™ is a feature that exercises the system by automatically applying power to the heater for about 30 seconds. If an alarm condition is detected during this period, then the TraceCheck™ Alarm is activated and a “ALARM DURING TRACECHECK” message is added to the System Status messages. If a ground fault is detected, the heater circuit is opened. This is a latching alarm. To clear the alarm, locate the alarm message in the Status Menu and press [RESET]. To disable this feature set the value to “off”. TraceCheck™ decreases maintenance by providing an early warning of problems that would otherwise go undetected until the heater was needed.

HEATER VOLTAGE:
120 V 

MESSAGE NO: S1-23 APPLIES TO: Selected Heater
 DEFAULT VALUE: 120V VALUE RANGE: 100 to 600 V, (measured)
 DISPLAY MODE: Advanced RESTRICTIONS: none

This functions sets the Heater Voltage. For 1-point and 2-point Control Modules with circuits at 300 V or less, set to “measured”. Otherwise, set to the heater supply voltage. This value is used to compute Energy Used and Energy Cost.

LOW VOLTAGE
ALARM: 100 V 

MESSAGE NO: S1-24 APPLIES TO: Selected Heater
 DEFAULT VALUE: off VALUE RANGE: 0 to 300 V, off
 DISPLAY MODE: Advanced RESTRICTIONS: Single Phase, 1 and 2 point modules



This function sets the Low Voltage Alarm setpoint. To disable this alarm set the value to “off”. When the Heater Voltage is less than or equal to this setpoint, the Low Voltage Alarm is activated and a “LOW VOLTAGE ALARM” message is added to the System Status messages. The alarm deactivates when the Heater Voltage rises above this alarm setpoint.

Setpoints: Heater Setup Menu

SETPOINTS:
HEATER SETUP

MESSAGE NO: S2-01 APPLIES TO: Interface Module
 DEFAULT VALUE: N/A VALUE RANGE: N/A
 DISPLAY MODE: Advanced RESTRICTIONS: None

This message displays the name of the sub-menu when entered.

SELECT HT: 1-1 
NONAME 

MESSAGE NO: S2-02 APPLIES TO: Interface Module
 DEFAULT VALUE: Selected Htr VALUE RANGE: Set by MODULE RANGE function

DISPLAY MODE: Advanced RESTRICTIONS: None

This function selects the heater circuit. Each heater circuit has a unique two-part Heater Number. The first part is the Module Number and the second part is the heater circuit within the Control Module. Press [VALUE ↑] or [VALUE ↓] and then press [STORE] to select a heater circuit. For convenience and to reduce human error, the Heater Name is also displayed.

MASTERTRACE

HEATER NAME:
NONAME ↗

MESSAGE NO: S2-03 APPLIES TO: Selected Heater
DEFAULT VALUE: NONAME VALUE RANGE: 16 Alphanumeric Characters
DISPLAY MODE: Advanced RESTRICTIONS: None

This functions sets the Heater Name. It provides a unique, identifiable tag or label for each heater circuit. The Heater Name consists of 16 alphanumeric characters which are entered one at a time from left to right. The cursor indicates which character is being selected. Press [VALUE↑] or [VALUE↓] to change the character. Move to the next character by pressing [STORE]. Continue in this fashion until all 16 characters are entered. Press [STORE] in the last character position to save the Heater Name.

MASTER OVERRIDE:
off ↗

MESSAGE NO: S2-04 APPLIES TO: Selected Heater
DEFAULT VALUE: off VALUE RANGE: on, off
DISPLAY MODE: Advanced RESTRICTIONS: None

This feature sets the response of the heater circuit to the Control Modules Master Override input. The Master Override input responds to a contact closure. If the Master Override is set to “off” or the Master Override inputs are shorted, then control of the heater circuit operates normally based on the Heater Control Temperature and the Heater Setpoint. If the Master Override is set to “on” and the Master Override inputs are open, then the heater circuit is opened regardless of the Heater Control Temperature. This feature allows selected circuits to be turned off for load shedding or for an ambient temperature override. If the Heater Setpoint is set to “off” or “none” and the Master Override is set to “on”, then the Master Override input will have full control over the heater circuit.

PROPORTIONAL
CONTROL: off ↗

MESSAGE NO: S2-05 APPLIES TO: Selected Heater
DEFAULT VALUE: off VALUE RANGE: on, off
DISPLAY MODE: Advanced RESTRICTIONS: Solid-State Modules

This functions minimizes temperature overshoot and undershoot for tighter temperature control. For critical temperature maintenance applications more accurate control can be obtained by using this feature. However, the time to reach Heater Setpoint may be longer. With Proportional Control set to “on”, as the Heater Control Temperature approaches the Heater Setpoint, the percent duty cycle of the heater is reduced. With Proportional Control set to “off”, on-off control is used.

DEADBAND
5C° ↗

MESSAGE NO: S2-06 APPLIES TO: Selected Heater
DEFAULT VALUE: 1 C° VALUE RANGE: 0 to 50 C°
DISPLAY MODE: Advanced RESTRICTIONS: Proportional Control must be “off”

This feature sets the size of the DEADBAND for on-off control. Decreasing the DEADBAND increases the temperature control accuracy but also increases the heater switching frequency and wear on mechanical contacts.

IF RTD FAILS
HEATER GOES: off 

MESSAGE NO: S2-07 APPLIES TO: Selected Heater
DEFAULT VALUE: off VALUE RANGE: on, off
DISPLAY MODE: Advanced RESTRICTIONS: None

This function sets the heater fail-safe state. The Control Module detects if the temperature sensor has failed. In this case it will use only the second RTD input, if available, or it will set the heater to its fail-safe state. For freeze protection where there is no hazard from over heating, set to “on” to prevent freeze up. Where there is a potential hazard from over heating, set to “off”.

RTD MODE:
1 RTD 

MESSAGE NO: S2-08 APPLIES TO: Selected Heater
DEFAULT VALUE: 1 RTD VALUE RANGE: See list below
DISPLAY MODE: Advanced RESTRICTIONS: Dual RTD Modules

This function sets how the Heater Control Temperature is derived from dual RTD inputs as follows.



<u>Value</u>	<u>Heater Control Temperature</u>
1 RTD	RTD-A
RTD B HT cutoff	RTD-A but less than RTD-B
2 RTDs, lowest	Minimum of RTD-A & RTD-B
2 RTDs, highest	Maximum of RTD-A & RTD-B
2 RTDs, averaged	Average of RTD-A & RTD-B
2 RTDs, backup	RTD-A if okay, else RTD-B

When RTD B HT cutoff is selected, RTD_B temperature is compared with the high temperature alarm. When RTD-B temperature is equal to or greater than the high temperature alarm setting the heater is turned off regardless if RTD-A temperature is less than the heater setpoint.

Setpoints: System Setup Menu

SETPOINTS:
SYSTEM SETUP

MESSAGE NO: S3-01 APPLIES TO: Interface Module
DEFAULT VALUE: N/A VALUE RANGE: N/A
DISPLAY MODE: All RESTRICTIONS: None
This message displays the name of the sub-menu when entered.

MODULE LIST
MOD:1  SEL:yes 

MESSAGE NO: S3-02 APPLIES TO: Interface Module
DEFAULT VALUE: MOD: 1 VALUE RANGE: MOD: Set by MODULE
SEL: no RANGE
SEL: yes, no

DISPLAY MODE: Advanced RESTRICTIONS: MR100 Interface
This function selects which Control Modules are monitored. All Control Modules that are to be monitored from the Interface Module must have SEL set to “yes”. All Control Modules that are not physically connected to the Interface Module must have SEL set to “no”. With the cursor to the right of MOD choose the Module Number by pressing [VALUE ↑] or [VALUE ↓] and then [STORE]. With the cursor to the right of SEL select “yes” to select or “no” to deselect the Control Module for monitoring by pressing [VALUE ↑] or [VALUE ↓] and then [STORE].

MODULE RANGE
1-30 ✍

MESSAGE NO: S3-03 APPLIES TO: Interface Module
DEFAULT VALUE: 1-30 VALUE RANGE: 1-30, 31-60, ... , 211-240,
241-254
DISPLAY MODE: Advanced RESTRICTIONS: MR100 Interface
This function selects the range of Control Module numbers connected to this Interface Module. All Control Modules connected to this Interface Module must be within this range.

DISPLAY MODE:
advanced user ✍

MESSAGE NO: S3-04 APPLIES TO: Interface Module
DEFAULT VALUE: advanced user VALUE RANGE: advanced user, normal user
DISPLAY MODE: All RESTRICTIONS: None
This function determines what messages are displayed. If set to “advanced user”, all messages are displayed. If set to “normal user”, only the basic messages are displayed. Each message listed in this appendix shows the Display Mode required to see the message. “Advanced” indicates that the display mode must be set to “advanced user” to view the message.

DEFAULT DISPLAY:
System Status ✍

MESSAGE NO: S3-05 APPLIES TO: Interface Module
DEFAULT VALUE: System status VALUE RANGE: See values below
DISPLAY MODE: Advanced RESTRICTIONS: None
This function specifies the information that will be displayed when no key has been pressed for the Display Timeout interval as described below.

<u>VALUE</u>	<u>INFORMATION DISPLAYED</u>
System status	Alarm status of all the heaters
Heater status	Heater status of selected heater
Heater temp	Temperature of the selected heater
Scan heater	All measured values of the selected heater
Scan temps	Temperatures of all enabled heaters
Scan currents	Phase currents of all enabled heaters
Scan gnd faults	Ground fault currents of all enabled heaters
Scan all heaters	All measured values of all enabled heaters

DISPLAY TIMEOUT:
60 seconds ✍

MESSAGE NO: S3-06 APPLIES TO: Interface Module
DEFAULT VALUE: 60 seconds VALUE RANGE: 5 to 600 s, off
DISPLAY MODE: Advanced RESTRICTIONS: None
This function sets the length of time, from the last key press, to automatically return to the Default Display information. To disables this function set the value to “off”.

SCAN TIME:
2 seconds ✍

MESSAGE NO: S3-07 APPLIES TO: Interface Module
DEFAULT VALUE: 3 seconds VALUE RANGE: 1 to 10 seconds
DISPLAY MODE: Advanced RESTRICTIONS: None
This function sets the length of time between the display of successive messages. Select a value that is comfortable for the reading speed of the operator.

TEMPERATURE UNITS:
Celsius 

MESSAGE NO: S3-08 APPLIES TO: Interface Module
 DEFAULT VALUE: Celsius VALUE RANGE: Celsius, Fahrenheit
 DISPLAY MODE: Advanced RESTRICTIONS: None
 This function sets the units of measure for temperature. All temperatures are displayed in the selected units of either Celsius degrees (C°) or Fahrenheit degrees (F°).

COST PER kWh:
\$0.05 

MESSAGE NO: S3-09 APPLIES TO: Selected Control Module
 DEFAULT VALUE: \$0.05 VALUE RANGE: \$0.01 to \$0.50
 DISPLAY MODE: Advanced RESTRICTIONS: None
 This function sets the COST PER kWh. This value is used to calculate Energy Cost.

STAGGER START:
on 

MESSAGE NO: S3-10 APPLIES TO: Selected Control Module
 DEFAULT VALUE: off VALUE RANGE: on, off
 DISPLAY MODE: Advanced RESTRICTIONS: None
 This feature staggers the power up of heater circuits to eliminate tripping of the main breaker. For all Control Modules with this value set to “on” the following sequence occurs at power up based on a minimum of 10 circuits. About 10% of the heaters circuits are turned on, there is a one minute delay and then the next 10% are turned on until all circuits are energized.
Note: Stagger Start is a module setpoint, if this setpoint is set to “on”, Stagger Start will only be applied to the selected module. Stagger Start will not be applied to the whole system.

SWITCH TYPE:
none 

MESSAGE NO: S3-11 APPLIES TO: Selected Control Module
 DEFAULT VALUE: Solid-state VALUE RANGE: Solid-state, Mechanical
 DISPLAY MODE: Advanced RESTRICTIONS: Solid State Module
 This function sets the type of switch used on the control module. Switch type is either solid-state or mechanical. When mechanical is selected, powerlimit and proportional control functions are disabled because both functions switch heater current at the zero cross points, very rapidly, and can damage mechanical switches.
Note: Switch Type is a module setpoint, and the stored value will only be applied to the selected module.

BAUD RATE MR100:
1200 

MESSAGE NO: S3-12 APPLIES TO: Interface Module
 DEFAULT VALUE: 1200 VALUE RANGE: 600,1200,2400,4800,9600
 DISPLAY MODE: Advanced RESTRICTIONS: MR100 Interface Module
 This function sets the communication baud rate for the MR100 serial port .

BAUD RATE 1:
1200 

MESSAGE NO: S3-13 APPLIES TO: Interface Module
 DEFAULT VALUE: 1200 VALUE RANGE: 600,1200,2400,4800,9600
 DISPLAY MODE: Advanced RESTRICTIONS: None
 This function sets the communication baud rate for serial port #1 of the controller. If the display interface is an ML100, the baud rate applies to the control module it is connected to. If the display interface is an MR100, the baud rate applies to serial port #1 of the module selected.

RESET CONTROL
MODULE? no 

yes [STORE]

ARE YOU SURE?
no 

yes [STORE]

SET ADDR ENABLE
ADDRESS LED ON



CONT - MSSG DOWN
ABORT - RESET

ABOUT TO RESET
MODULE



CONT - MSSG DOWN
ABORT - RESET

[MSSG↓]

MODULE RESET



PRESS MSSG DOWN
TO CONTINUE

[MSSG↓]

SET ADDR DISABLE
ADDRESS LED OFF



PRESS MSSG DOWN
TO CONTINUE

MESSAGE NO: S3-18 APPLIES TO: Address Enabled Control Module

DEFAULT VALUE: no VALUE RANGE: yes, no

DISPLAY MODE: Advanced RESTRICTIONS: MR100 Interface Module

This function resets all values of the Control Module which has been placed in Address Enabled mode. Select “yes” to proceed. Select “yes” again to confirm. This message asks you to confirm that the Control Module Address is “enabled”. The Control Module Address light must be on. Press [MSSG ↓] to proceed. Refer *Chapter 5.1.2*.

MESSAGE NO: S3-18a APPLIES TO: Address Enabled Control Module

DEFAULT VALUE: None VALUE RANGE: None

DISPLAY MODE: Advanced RESTRICTIONS: MR100 Interface Module

This message provides a last chance to confirm the Reset Module function. Press [MSSG ↓] to continue.

This message asks you to disable Address Mode and check that the Control Module Address LED is off. Press [MSSG ↓] to continue. Refer to *Chapter 5.1.2*.

NO RESPONSE
ADDRESS LED OFF?



PRESS MSSG DOWN
TO CONTINUE

MESSAGE NO: S3-18b APPLIES TO: Address Enabled Control Module
DEFAULT VALUE: None VALUE RANGE: None
DISPLAY MODE: Advanced RESTRICTIONS: MR100 Interface Module
If you receive the message “NO RESPONSE ...”, check that the Control Module Address is “enabled” or refer to *Appendix C: Summary of Alarms and their Causes, NO RESPONSE ALARM*. Press [MSSG ↓] to proceed.

SET MODULE
NUMBER? no ✍

yes [STORE]

ARE YOU SURE?
no ✍

yes [STORE]

ENTER MODULE #:
1 ✍

[STORE]

SET ADDR ENABLE
ADDRESS LED ON



CONT - MSSG DOWN
ABORT - RESET

MESSAGE NO: S3-19 APPLIES TO: Address Enabled Control Module
DEFAULT VALUE: no VALUE RANGE: yes, no
DISPLAY MODE: Advanced RESTRICTIONS: MR100 Interface Module
This function changes the Module Number of a connected Control Module which has been placed in Address Enabled mode. Select “yes” to proceed. Select “yes” again to confirm.

Enter the new Module Number. The Module Number of each Control Module on a data highway or connected to a MR100 Interface Module must be unique. Select the Module Number by pressing [VALUE ↑] or [VALUE ↓] and then [STORE].

This message asks you to confirm that the Control Module Address is “enabled”. The Control Module Address light must be on. Press [MSSG ↓] to proceed. Refer to *Chapter 5.1.2*.

NO RESPONSE
ADDRESS LED OFF?



PRESS MSSG DOWN
TO CONTINUE

MESSAGE NO: S3-19a APPLIES TO: Address Enabled Control Module
DEFAULT VALUE: None VALUE RANGE: None
DISPLAY MODE: Advanced RESTRICTIONS: MR100 Interface Module
If you receive the message “NO RESPONSE ...”, check that the Control Module Address is “enabled” or refer to *Appendix C: Summary of Alarms and their Causes, NO RESPONSE ALARM*. Press [MSSG ↓] to proceed.

CHECKING MODULE
NUMBER: 1 



MODULE #1 
ALREADY EXISTS



PRESS MSSG DOWN
TO CONTINUE

ABOUT TO SET
NEW NUMBER



CONT - MSSG DOWN
ABORT - RESET



MODULE NUMBER
ASSIGNED



PRESS MSSG DOWN
TO CONTINUE



SET ADDR DISABLE
ADDRESS LED OFF





PRESS MSSG DOWN
TO CONTINUE

MESSAGE NO: S3-19b APPLIES TO: Address Enabled Control Module
DEFAULT VALUE: None VALUE RANGE: Module Range
DISPLAY MODE: Advanced RESTRICTIONS: MR100 Interface Module
The message “CHECKING MODULE NUMBER: n” is displayed while the system looks for a module that already has this number. If it finds a module with this number, the message “MODULE # 1 ALREADY EXISTS” is displayed. Press [MSSG 

MESSAGE NO: S3-19c APPLIES TO: Address Enabled Control Module
DEFAULT VALUE: None VALUE RANGE: None
DISPLAY MODE: Advanced RESTRICTIONS: MR100 Interface Module
This message provides a last chance to confirm the Module Number Change. Press [MSSG 

This message indicates that the SET MODULE Number function was successful. Press [MSSG 

This message asks you to disable Address Mode and check that the Control Module Address LED is off. Press [MSSG Chapter 5.1.2.

READ MODULE
NUMBER? no 

yes 

ARE YOU SURE?
no 

yes 

SET ADDR ENABLE
ADDRESS LED ON



CONT - MSSG DOWN
ABORT - RESET

NO RESPONSE
ADDRESS LED OFF?



PRESS MSSG DOWN
TO CONTINUE

MODULE NUMBER
1 



PRESS MSSG DOWN
TO CONTINUE

[MSSG 

SET ADDR DISABLE
ADDRESS LED OFF



PRESS MSSG DOWN
TO CONTINUE

MESSAGE NO: S3-20 APPLIES TO: Address Enabled Control Module

DEFAULT VALUE: no VALUE RANGE: yes, no
DISPLAY MODE: Advanced RESTRICTIONS: MR100 Interface Module

This function reads the Module Number of a Control Module with Address Enabled. The Module Number of each Control Module on a data highway or connected to a MR100 Interface Module is unique. Select “yes” to proceed. Select “yes” again to confirm.

This message asks you to confirm that the Control Module Address is “enabled”. The Control Module Address light must be on. Press [MSSG 

MESSAGE NO: S3-20a APPLIES TO: Address Enabled Control Module

DEFAULT VALUE: None VALUE RANGE: None
DISPLAY MODE: Advanced RESTRICTIONS: MR100 Interface Module

If you receive the message “NO RESPONSE ...”, check that the Control Module Address is “enabled” or refer to *Appendix C: Summary of Alarms and their Causes, NO RESPONSE ALARM*. Press [MSSG 

MESSAGE NO: S3-20b APPLIES TO: Address Enabled Control Module

DEFAULT VALUE: None VALUE RANGE: Module Range
DISPLAY MODE: Advanced RESTRICTIONS: MR100 Interface Module

This message displays the Module Number and indicates that the READ MODULE function was successful. Press [MSSG 

This message asks you to disable Address Mode and check that the Control Module Address LED is off. Press [MSSG 

RESET MR100?
no 

yes [STORE]

ARE YOU SURE?
no 

yes [STORE]

MR100
CLEARED

MESSAGE NO: S3-21 APPLIES TO: MR100 Interface Module
DEFAULT VALUE: no VALUE RANGE: yes, no
DISPLAY MODE: Advanced RESTRICTIONS: MR100 Interface Module
This function resets all values of the MR100 Interface Module to the default values. Select “yes” to proceed. Select “yes” again to confirm.

This message confirms that the MR100 Interface Module was reset.

FIRMWARE VERSION
D1-02-01

MESSAGE NO: S3-22 APPLIES TO: Interface Module
DEFAULT VALUE: N/A VALUE RANGE: N/A
DISPLAY MODE: Advanced RESTRICTIONS: None
This message displays the firmware version number.

MANUAL VERSION:
1501-0006_1

MESSAGE NO: S3-23 APPLIES TO: Interface Module
DEFAULT VALUE: N/A VALUE RANGE: N/A
DISPLAY MODE: Advanced RESTRICTIONS: None
This message displays the operation manual version or reorder number.

FOR ASSISTANCE:
(403)735-9555

MESSAGE NO: S3-24 APPLIES TO: Interface Module
DEFAULT VALUE: N/A VALUE RANGE: N/A
DISPLAY MODE: Advanced RESTRICTIONS: None
This message displays the factory telephone number.

MASTERTRACE

HEATER VOLTAGE
120V 

MESSAGE NO: M1-12 APPLIES TO: Selected Heater
DEFAULT VALUE: N/A VALUE RANGE: 0 to 300 V
DISPLAY MODE: All RESTRICTIONS: Single-pole 1 and 2 point
modules

The displayed value is the measured supply voltage.

GROUND FAULT
CURRENT: 5mA 

MESSAGE NO: M1-13 APPLIES TO: Selected Heater
DEFAULT VALUE: N/A VALUE RANGE: 0 to 1000 mA
DISPLAY MODE: All RESTRICTIONS: None



The displayed value is the ground leakage or ground fault current. If the current exceeds the value range then “O.L.” is displayed.

Measured Values: Statistics Menu

MEASURED VALUES:
STATISTICS 

MESSAGE NO: M2-01 APPLIES TO: Interface Module
DEFAULT VALUE: N/A VALUE RANGE: N/A
DISPLAY MODE: Advanced RESTRICTIONS: None

This message displays the name of the sub-menu when entered.

SELECT HT: 1-1 
NONAME 

MESSAGE NO: M2-02 APPLIES TO: Interface Module
DEFAULT VALUE: Selected Htr VALUE RANGE: Set by MODULE RANGE
function

DISPLAY MODE: Advanced RESTRICTIONS: None
This function selects the heater circuit. Each heater circuit has a unique two-part Heater Number. The first part is the Module Number and the second part is the heater circuit within the Control Module. Press [VALUE ↑] or [VALUE ↓] and then press [STORE] to select a heater circuit. For convenience and to reduce human error, the Heater Name is also displayed.

MIN TEMPERATURE:
3°C 

MESSAGE NO: M2-03 APPLIES TO: Selected Heater
DEFAULT VALUE: N/A VALUE RANGE: -50 to 350 °C
-58 to 662 °F

DISPLAY MODE: Advanced RESTRICTIONS: None
The displayed value is the lowest Heater Control Temperature since the last reset. If the displayed value is “RTD SHORT”, a value less than the minimum range was recorded. To reset the displayed value press [RESET]. To reset with all statistics use RESET STATISTICS function.

MAX TEMPERATURE:
25°C 

MESSAGE NO: M2-04 APPLIES TO: Selected Heater
DEFAULT VALUE: N/A VALUE RANGE: -50 to 350 °C
-58 to 662 °F

DISPLAY MODE: Advanced RESTRICTIONS: None
The displayed value is the highest Heater Control Temperature since the last reset. If the displayed value is “RTD OPEN”, a value greater than the maximum range was recorded. To reset the displayed value press [RESET]. To reset with all statistics use RESET STATISTICS function.

MASTERTRACE

MAX HEATER CURRENT
4.7A 

MESSAGE NO: M2-05 APPLIES TO: Selected Heater
 DEFAULT VALUE: N/A VALUE RANGE: 0 to 100.0 A
 DISPLAY MODE: Advanced RESTRICTIONS: Single-Phase Modules
 The displayed value is the highest Heater Current since the last reset. The maximum value range for internal switching modules is 30.0 A. If the displayed value is "O.L.", a value greater than the maximum range was recorded. To reset the displayed value press [RESET]. To reset with all statistics use RESET STATISTICS function.

A: MAX HEATER CURRENT
4.7A 

MESSAGE NO: M2-06 APPLIES TO: Selected Heater
 DEFAULT VALUE: N/A VALUE RANGE: 0 to 100.0 A
 DISPLAY MODE: Advanced RESTRICTIONS: Three-Phase Modules
 The displayed value is the highest Heater Current-A since the last reset. If the displayed value is "O.L.", a value greater than the maximum range was recorded. To reset the displayed value press [RESET]. To reset with all statistics use RESET STATISTICS function.

B: MAX HEATER CURRENT
4.7A 

MESSAGE NO: M2-07 APPLIES TO: Selected Heater
 DEFAULT VALUE: N/A VALUE RANGE: 0 to 100.0 A
 DISPLAY MODE: Advanced RESTRICTIONS: Three-Phase Modules
 The displayed value is the highest Heater Current-B since the last reset. If the displayed value is "O.L.", a value greater than the maximum range was recorded. To reset the displayed value press [RESET]. To reset with all statistics use RESET STATISTICS function.

C: MAX HEATER CURRENT
4.6A 

MESSAGE NO: M2-08 APPLIES TO: Selected Heater
 DEFAULT VALUE: N/A VALUE RANGE: 0 to 100.0 A
 DISPLAY MODE: Advanced RESTRICTIONS: Three-Phase Modules
 The displayed value is the highest Heater Current-C since the last reset. If the displayed value is "O.L.", a value greater than the maximum range was recorded. To reset the displayed value press [RESET]. To reset with all statistics use RESET STATISTICS function.

MAX GROUND FAULT
CURRENT: 6mA 

MESSAGE NO: M2-09 APPLIES TO: Selected Heater
 DEFAULT VALUE: N/A VALUE RANGE: 0 to 1000 mA
 DISPLAY MODE: Advanced RESTRICTIONS: None
 The displayed value is the highest Ground Fault Current since the last reset. If the displayed value is "O.L.", a value greater than the maximum range was recorded. To reset the displayed value press [RESET]. To reset with all statistics use RESET STATISTICS function.

ENERGY USED LAST
DAY: 2.1kWh 

MESSAGE NO: M2-10 APPLIES TO: Selected Heater
 DEFAULT VALUE: N/A VALUE RANGE: 0 to 1000 MWh
 DISPLAY MODE: Advanced RESTRICTIONS: None
 The displayed value is the energy used in the last day. Energy is calculated from the Heater Current times the Heater Voltage integrated over time. This value is automatically updated once every 24 hours. It cannot be reset.

TOTAL ENERGY
USED: 42.2kWh 

MESSAGE NO: M2-11 APPLIES TO: Selected Heater
DEFAULT VALUE: N/A VALUE RANGE: 0 to 1000 MWh
DISPLAY MODE: Advanced RESTRICTIONS: None

The displayed value is the energy used since the last reset. Energy is calculated from the Heater Current times the Heater Voltage integrated over time. To reset use RESET STATISTICS function.

ENERGY COST LAST
DAY: \$1.70 

MESSAGE NO: M2-12 APPLIES TO: Selected Heater
DEFAULT VALUE: N/A VALUE RANGE: \$0 to \$1,000,000.00
DISPLAY MODE: Advanced RESTRICTIONS: None

The displayed value is the energy cost in the last day. Energy cost is calculated from the Energy Used times the COST PER kWh. This value is automatically updated once every 24 hours. It cannot be reset.

TOTAL ENERGY
COST: \$33.92 

MESSAGE NO: M2-13 APPLIES TO: Selected Heater
DEFAULT VALUE: N/A VALUE RANGE: \$0 to \$1,000,000.00
DISPLAY MODE: Advanced RESTRICTIONS: None

The displayed value is the energy cost since the last reset. Energy cost is calculated from the Energy Used times the COST PER kWh. To reset use RESET STATISTICS function.

TIME SINCE RESET
48 hrs 

MESSAGE NO: M2-14 APPLIES TO: Selected Heater
DEFAULT VALUE: N/A VALUE RANGE: 0 to 1,000,000 hours
DISPLAY MODE: Advanced RESTRICTIONS: None

The displayed value is the elapsed time since last reset. To reset use RESET STATISTICS function.

HEATER ON TIME
80 hrs 

MESSAGE NO: M2-15 APPLIES TO: Selected Heater
DEFAULT VALUE: N/A VALUE RANGE: 0 to 999,999 hours
DISPLAY MODE: Advanced RESTRICTIONS: None

The displayed value is the accumulated time that the heater circuit has been on since the last reset. It indicates how active the heater circuit is and can be useful for maintenance. To reset use RESET STATISTICS function.

HEATER IS ON
 17% OF THE TIME

MESSAGE NO: M2-16 APPLIES TO: Selected Heater
DEFAULT VALUE: N/A VALUE RANGE: 0 to 100%
DISPLAY MODE: Advanced RESTRICTIONS: None

The displayed value is the percentage of time that the heater circuit has been on since the last reset. $\text{PERCENT ON TIME} = \text{HEATER ON TIME} \div \text{TIME SINCE RESET} \times 100\%$. It indicates how active the heater circuit is and can be useful for maintenance. Interpretation of this value will depend on the process but large changes could be an indication of degradation of the heater or the insulation. To reset use RESET STATISTICS function.

TOTAL RUN TIME:
20966 hrs 

MESSAGE NO: M2-17 APPLIES TO: Selected Control Module
DEFAULT VALUE: N/A VALUE RANGE: 0 to 1,000,000 hours
DISPLAY MODE: Advanced RESTRICTIONS: None
The displayed value is the total time since power was first applied to the Interface Module. It is useful for maintenance purposes. It cannot be reset.

RESET STATISTICS?
no 

MESSAGE NO: M2-18 APPLIES TO: Selected Control Module
DEFAULT VALUE: N/A VALUE RANGE: yes, no
DISPLAY MODE: Advanced RESTRICTIONS: None

This function resets all the statistical values except Total Run Time, Energy Used Last Day and Energy Cost Last Day. Select “yes” and then press [STORE]. You are asked to confirm your request. Again, select “yes” and then press [STORE]. The statistical values are now cleared. If the display interface is an ML100, this function resets the statistical values of all the Control Module heaters. If the display interface is an MR100, this function resets the statistical values of the selected heater.

ARE YOU SURE?
no 

Appendix C Summary of Alarms and their Causes

LOW TEMPERATURE
ALARM

The Heater Control Temperature is less than or equal to the Low Temperature Alarm setpoint. For dual RTD Control Modules, the RTD Mode determines how the Heater Control Temperature is derived.

- ✓ Check that the alarm setpoint is correct.
- ✓ Test for correct RTD operation.
- ✓ Check for damaged insulation or cladding.
- ✓ Check for damaged heat trace.
- ✓ Check the heat trace design.

HIGH TEMPERATURE
ALARM

The Heater Control Temperature is greater than or equal to the High Temperature Alarm setpoint. For dual RTD Control Modules, the RTD Mode determines how the Heater Control Temperature is derived.

- ✓ Check that the alarm setpoint is correct.
- ✓ Test for correct RTD operation.
- ✓ Check the heat trace design.

LOW CURRENT
ALARM

The measured Heater Current, when the heater circuit is on, is less than or equal to the Low Current Alarm setpoint. For three-phase Control Modules, the individual phase (A, B or C) is identified.

- ✓ Check that the alarm setpoint is correct.
- ✓ For self-regulating heating cable, the current varies substantially with temperature. Check that the alarm setpoint accounts for this variation.
- ✓ Test for correct current measurement.
- ✓ For parallel resistance heating cable, check for broken cable or failed splice or tee connection.
- ✓ For zone-type heating cable, check for failed zones.

HIGH CURRENT
ALARM

The measured Heater Current, when the heater circuit is on, is greater than or equal to the High Current Alarm setpoint or, the Heater Current is greater than the maximum value range. For three-phase Control Modules, the individual phase (A, B or C) is identified.

- ✓ Check that the alarm setpoint is correct.
- ✓ For self-regulating heating cable, the current varies substantially with temperature. Check that the alarm setpoint accounts for this variation.
- ✓ Test for correct current measurement.

HIGH CURRENT
TRIP

The measured Heater Current, when the heater circuit is on, is greater than or equal to the High Current Trip setpoint. For three-phase Control Modules, the individual phase (A, B or C) is identified.

- ✓ Check that the alarm setpoint is correct
- ✓ For self-regulating heating cable, the current varies substantially with temperature. Check that the alarm setpoint accounts for this variation.
- ✓ Test for current transformer failure by measuring Heater Current.

GROUND FAULT
ALARM

The measured ground fault current is greater than or equal to the Ground Fault Alarm setpoint or, the ground fault current is greater than the maximum value range.

- ✓ Check that the setpoint is appropriate for the length and type of cable.
- ✓ Check for wet or damaged heating cable, power connections, splices or tees.
- ✓ Test for correct ground fault measurement.

MASTERTRACE

GROUND FAULT
TRIP

The measured ground fault current is greater than or equal to the Ground Fault Trip setpoint.

- ✓ Check that the setpoint is appropriate for the length and type of cable.
- ✓ Check for wet or damaged heating cable, power connections, splices or tees.
- ✓ Test for correct ground fault measurement.

LOW VOLTAGE
ALARM

For single and dual-point Control Modules, the measured circuit voltage is less than or equal to the Low Voltage Alarm setpoint.

- ✓ Check for voltage input failure by measuring the voltage at the input. On internal switching modules, check the Heater Power In terminals; on external switching modules, check the Heater Voltage terminals.
- ✓ Check for breaker trip.

RTD FAILURE
ALARM

The temperature derived from the RTD resistance is outside the range of values for Heater Control Temperature.

- ✓ Check for damaged RTD, cable or connection.
- ✓ Test the RTD input.
- ✓ Several RTD Short Alarms indicate an RTD Board failure.
- ✓ RTD Open Alarm can indicate that a spare heater circuit is enabled.

SWITCH FAILURE
ALARM

The phase current is greater than or equal to 0.1 A when the heater circuit is off.

- ✓ Check for switch failure.
- ✓ Test the switch input or coil voltage. When the heater circuit is off, the input or coil voltage should be 0 Vdc. Otherwise the Module needs repair.

ALARM DURING
TRACECHECK

One of the following alarms occurred during the TraceCheck™ cycle. Refer to the alarm details above for the individual alarm.

- ✓ LOW CURRENT ALARM
- ✓ HIGH CURRENT ALARM
- ✓ HIGH CURRENT TRIP
- ✓ GROUND FAULT ALARM
- ✓ GROUND FAULT TRIP
- ✓ SWITCH FAILURE ALARM

NO RESPONSE
ALARM

For the Group Interface Module, indicates that a Control Module does not respond.

- ✓ If module does not exist on the data highway remove from the Module List.
- ✓ Check for damaged RS-485 cable.
- ✓ Check for Failed Control Module.

SELF TEST
FAILURE ALARM

A memory or CPU failure has occurred.

- ✓ If the alarm message occurs on the ML100 Dedicated Interface Module, the Control Module needs repair.
- ✓ If the alarm occurs on the MR100 Group Interface Module, the Group Interface Module needs repair.

GF TEST
ALARM

Ground fault monitoring function did not detect the GF test current.

- ✓ Check ground fault current transformer wiring to terminals.
- ✓ Ground fault current transformer may be faulty.

MASTERTRACE

Appendix D Typical Wiring Diagrams

MS-1DXH0

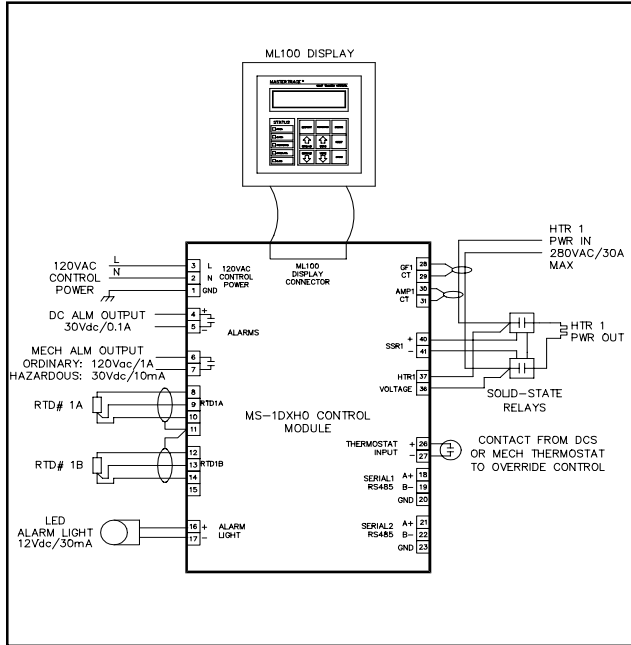

MS-1DIN2

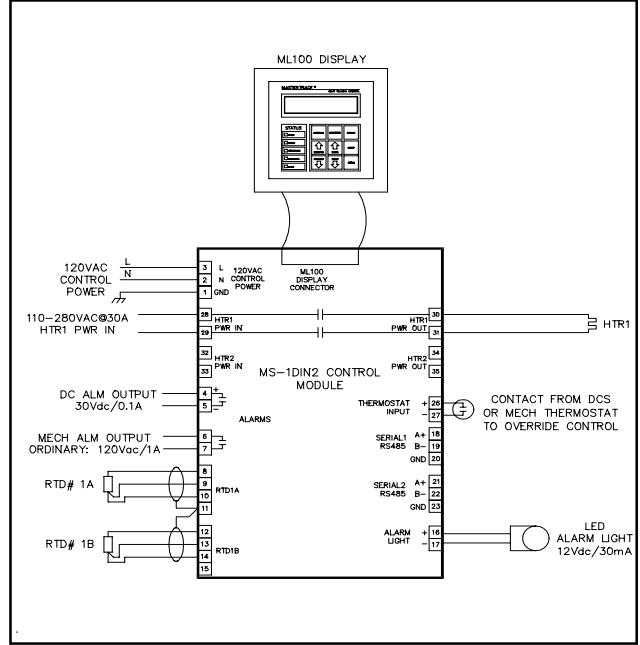

MS-1TXH0

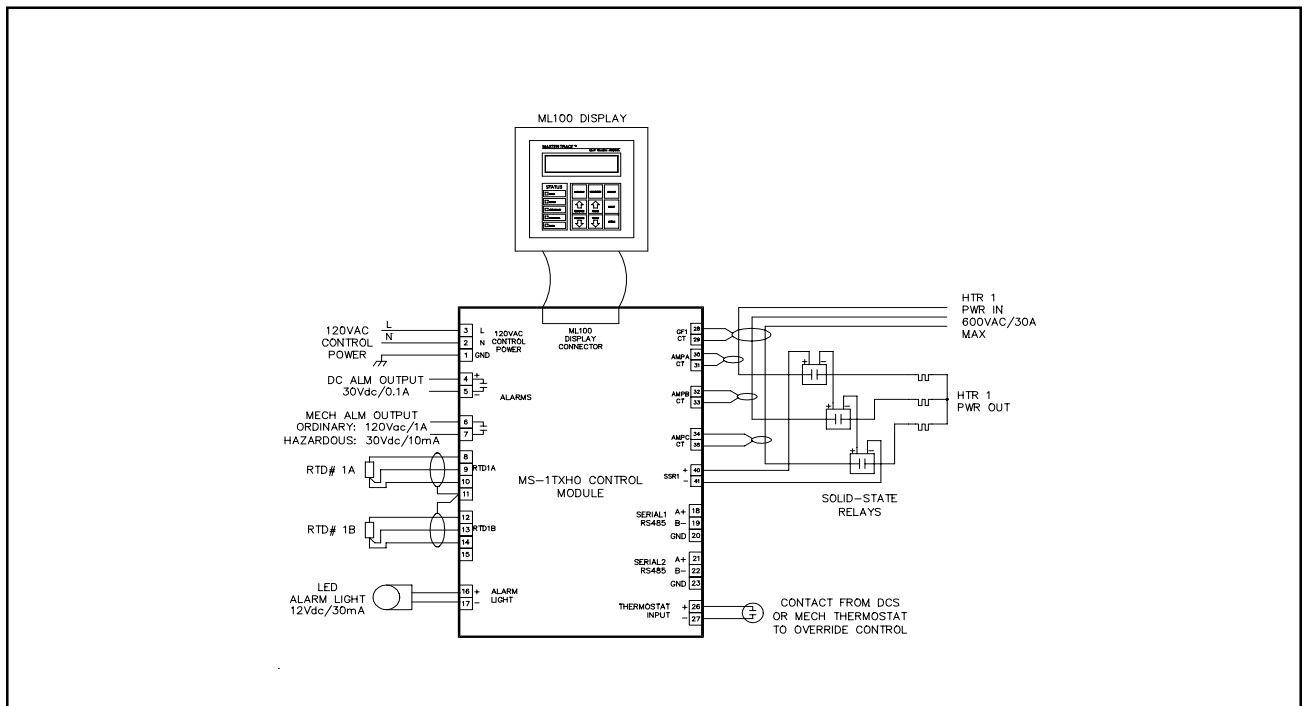

MASTERTRACE

Appendix D Typical Wiring Diagrams

MS-2DXH0

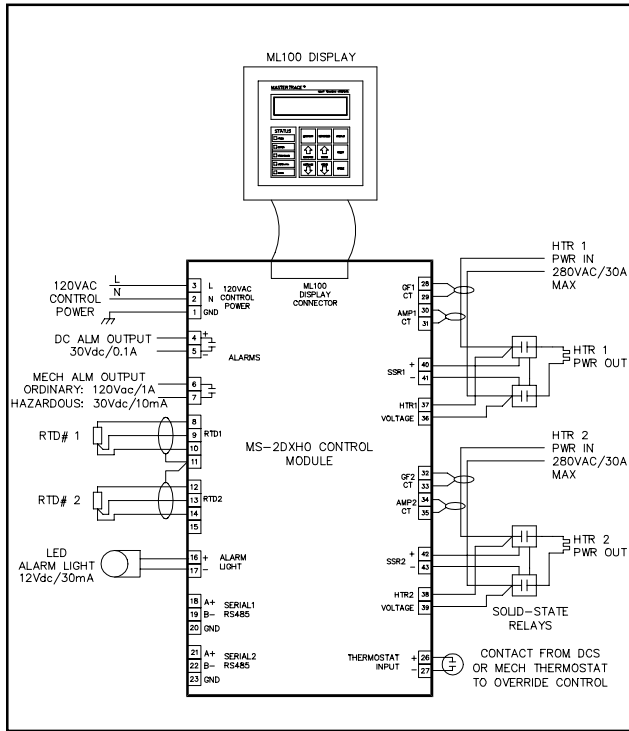

MS-2DIN2

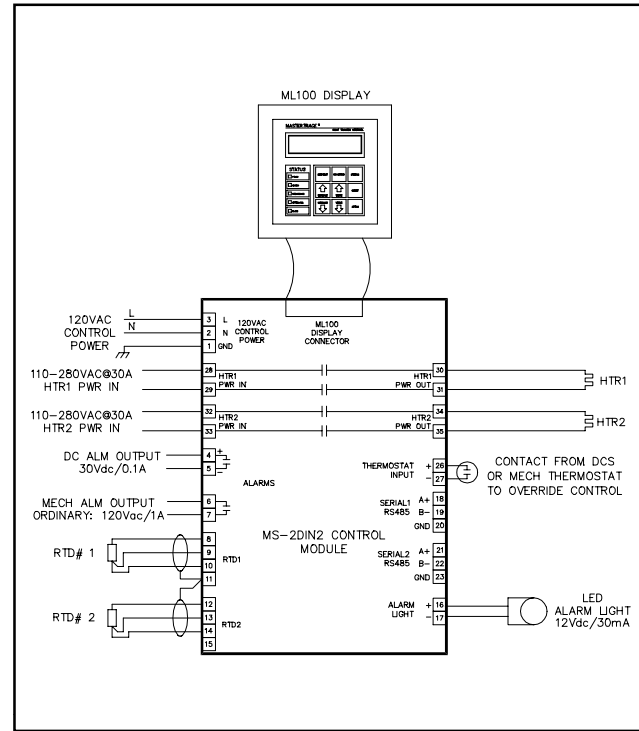

MS-5ADXH0

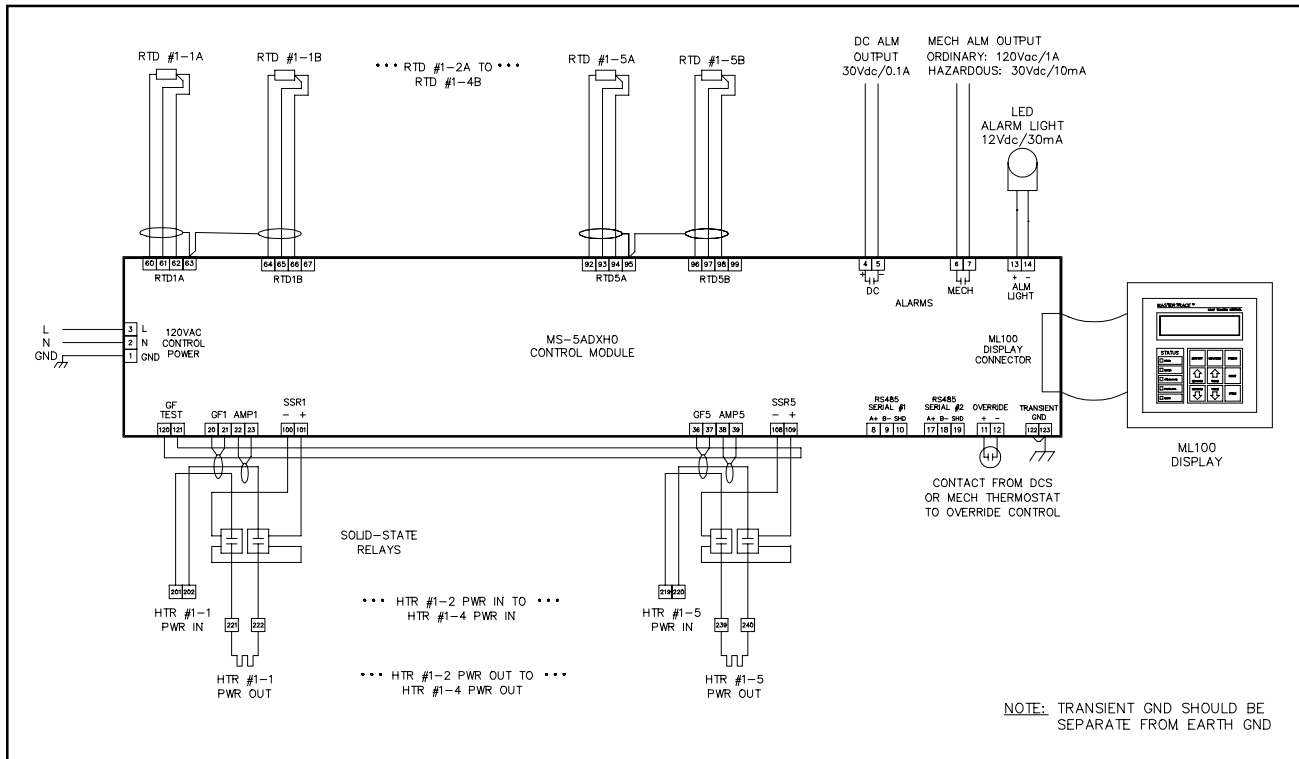

NOTE: TRANSIENT GND SHOULD BE SEPARATE FROM EARTH GND

MASTERTRACE

MS-5ADIN2

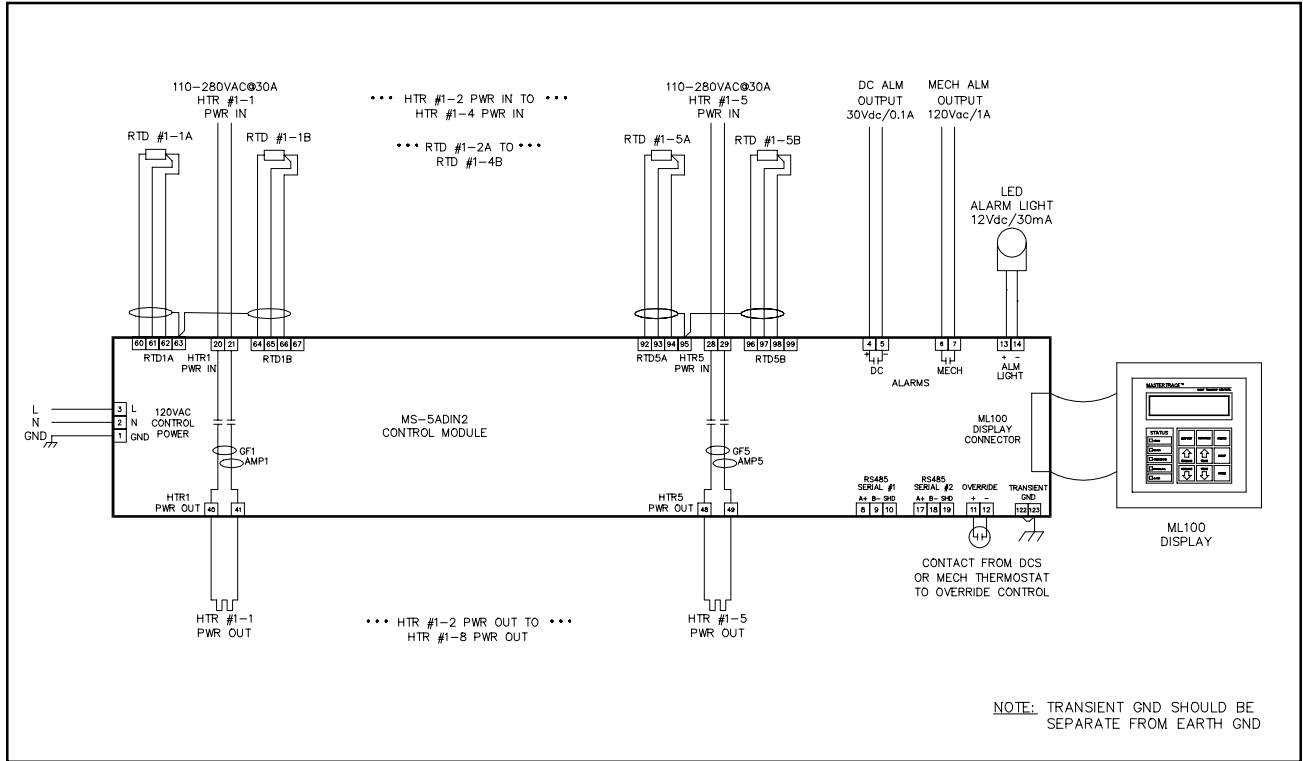

MS-5ATXH0

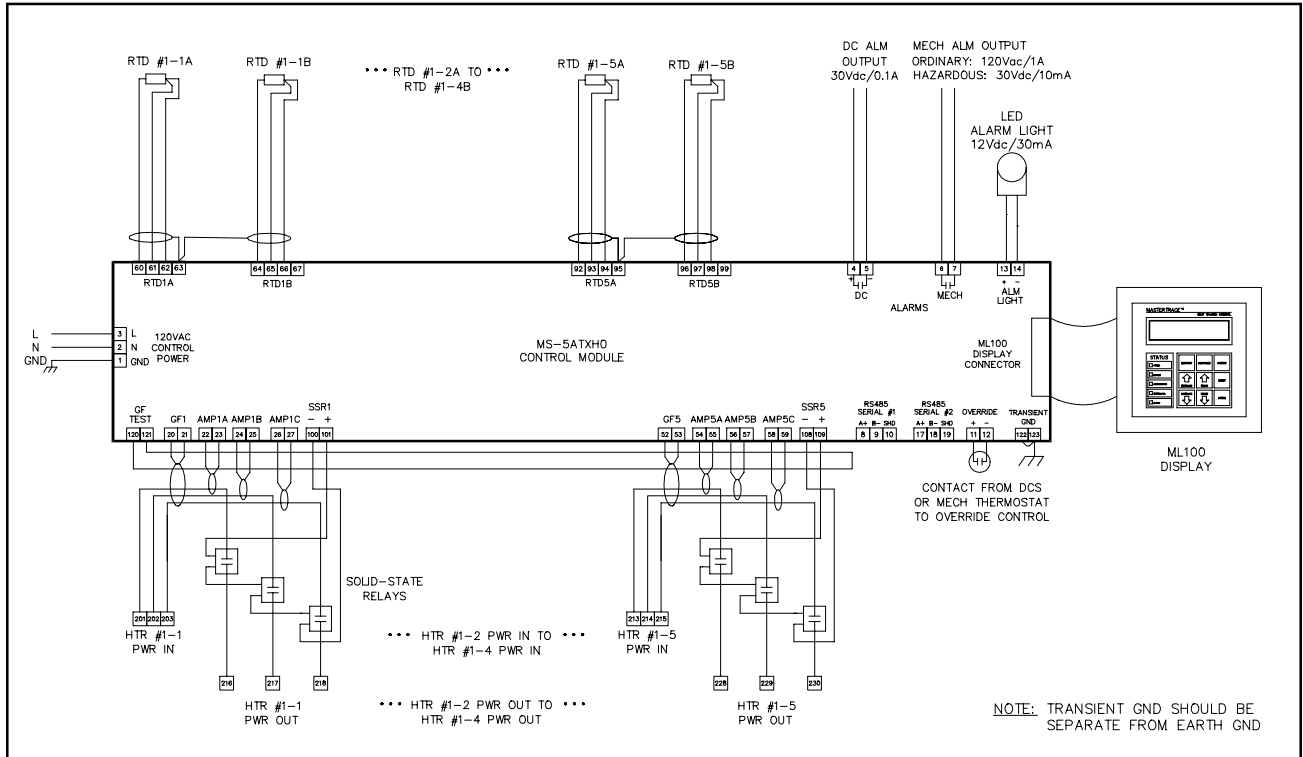

MASTERTRACE

Appendix D Typical Wiring Diagrams

MS-10ADXHO

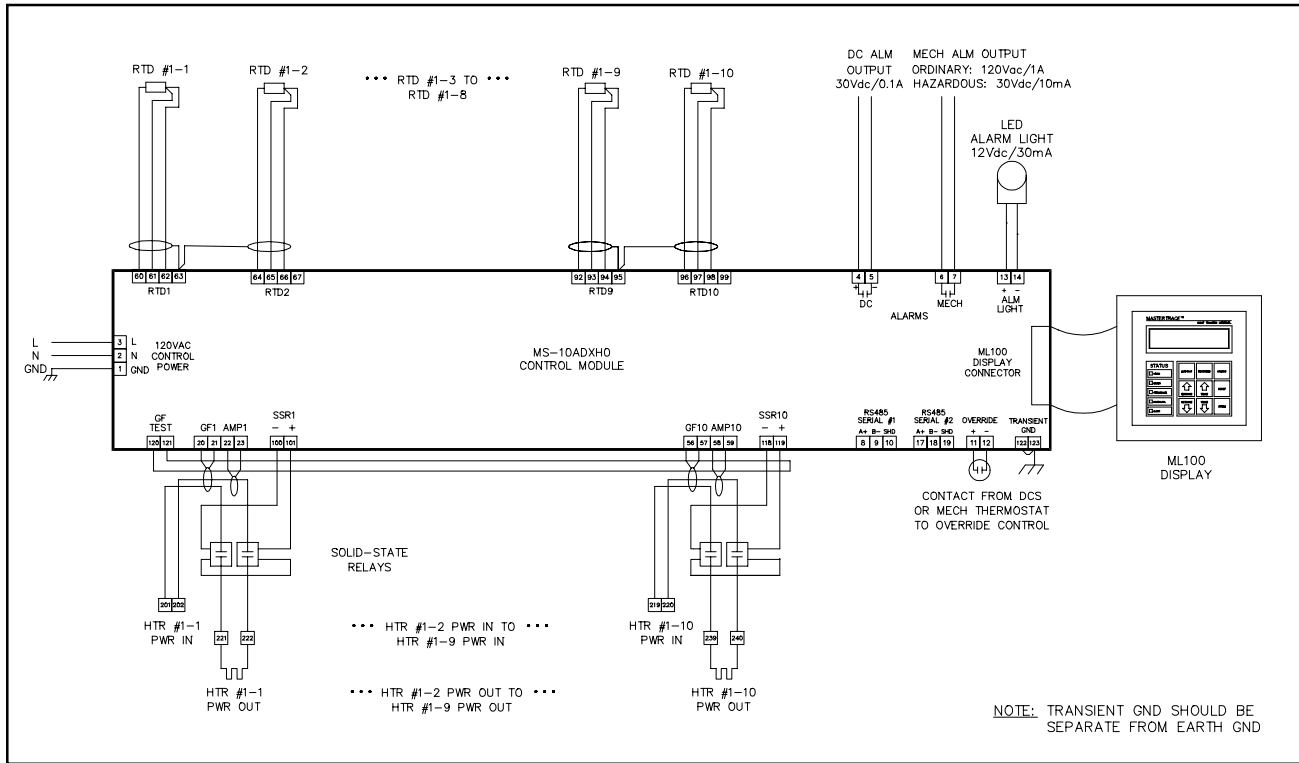

MS-10ADIN2

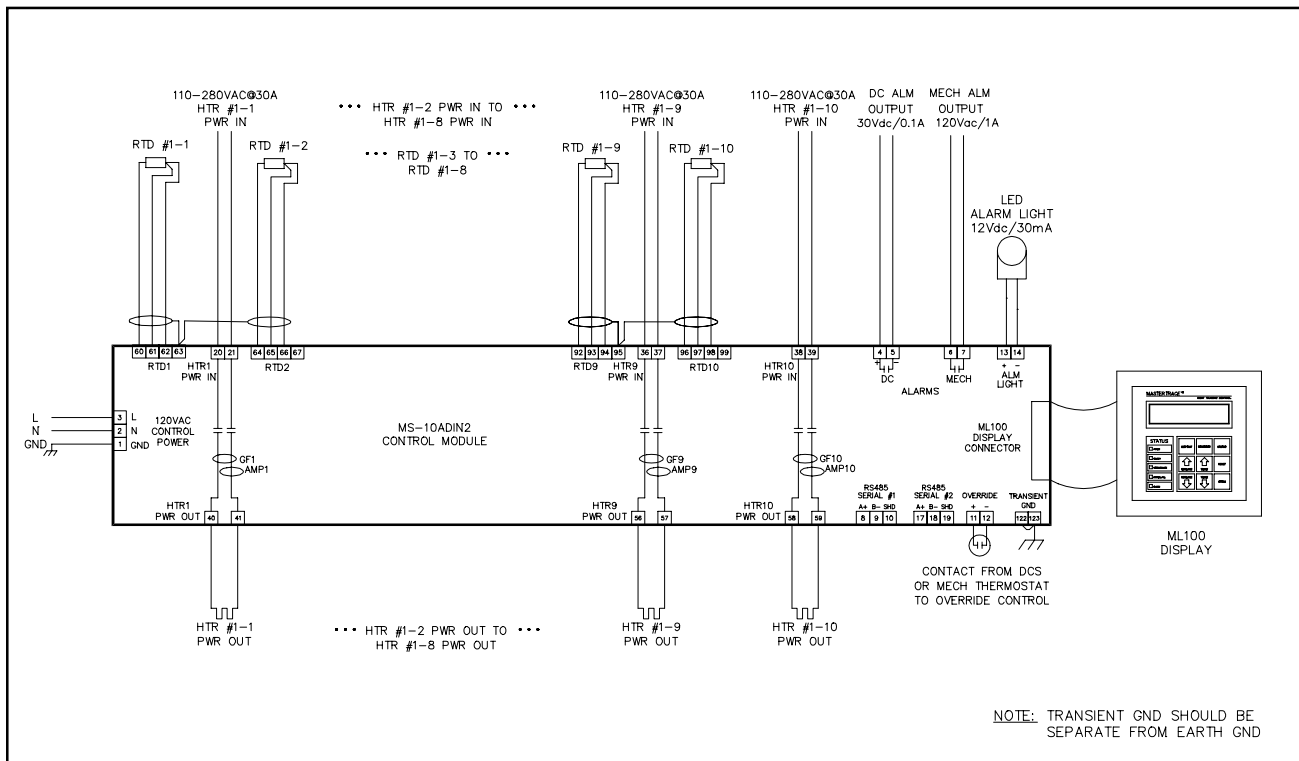

MASTERTRACE

Driving Contactors

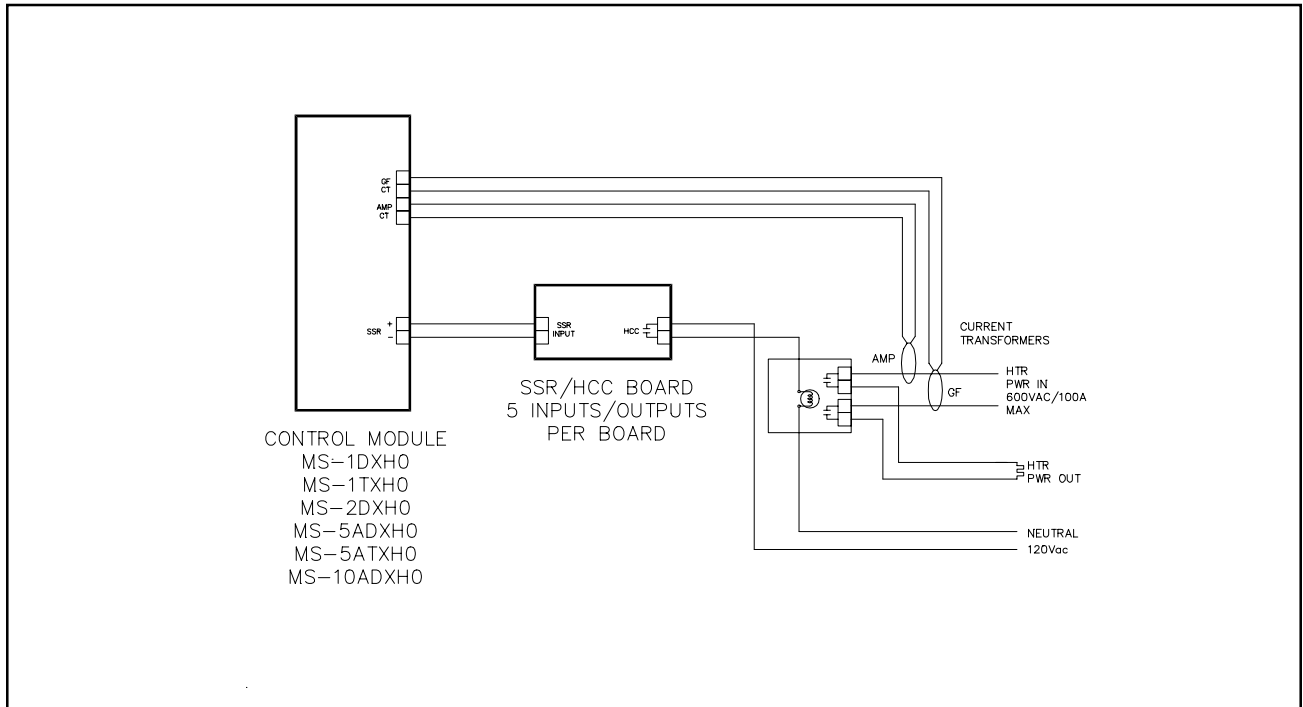

Serial Communications

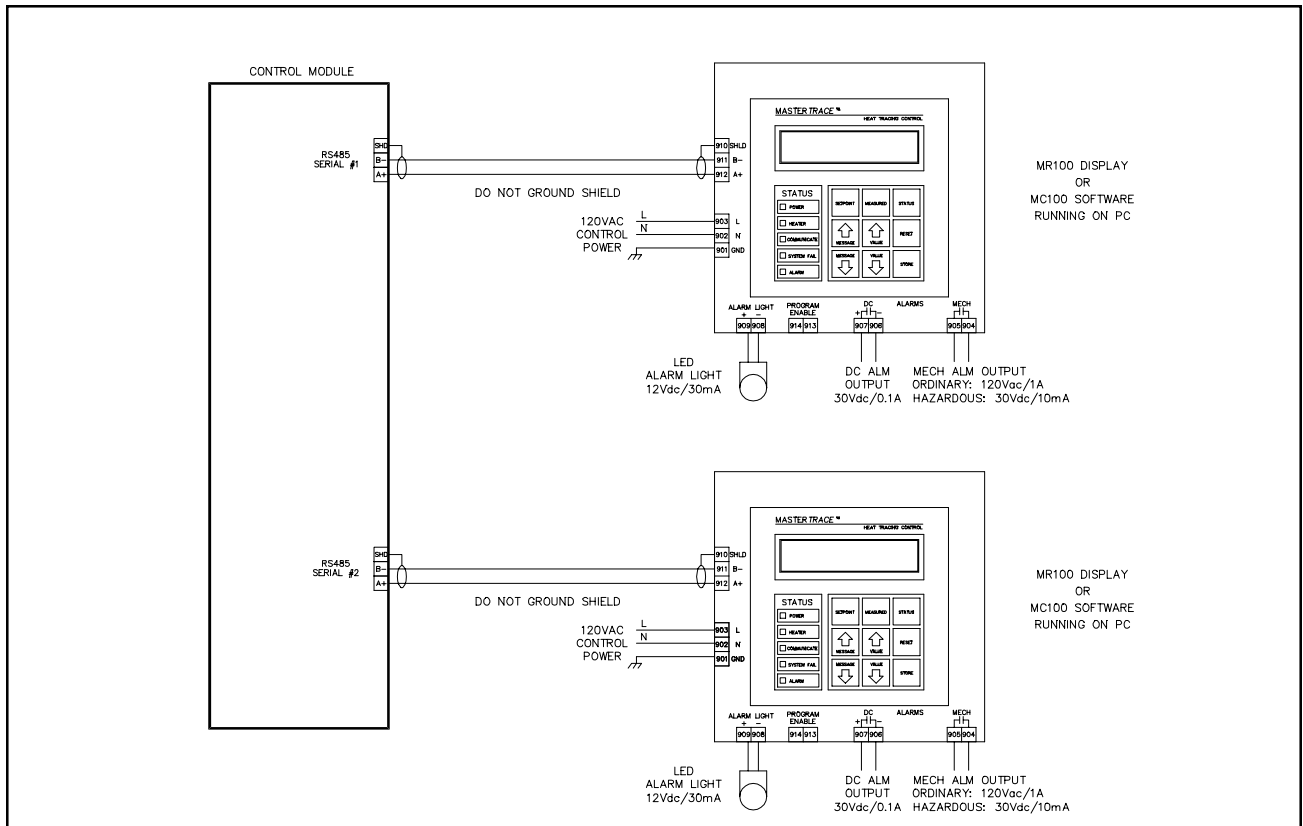

Warranty

The manufacturer warrants each control that it manufactures to be free from defective material or workmanship for a period of 12 months from date of purchase.

Under this warranty, the obligation of the manufacturer is limited to repairing or replacing the defective control at its option, when returned to the manufacturer's factory with shipping charges prepaid.

If failure has been caused by misuse, incorrect application or alteration of the control, this warranty will be void.

UNLESS SPECIFICALLY PROVIDED FOR IN WRITING IN THIS WARRANTY, EACH CONTROL IS PROVIDED WITHOUT ANY WARRANTY OF ANY KIND EITHER EXPRESSED OR IMPLIED. IN PARTICULAR, WITHOUT LIMITING THE GENERALITY OF THE FOREGOING, THE FOLLOWING IMPLIED WARRANTIES AND CONDITIONS ARE EXPRESSLY DISCLAIMED:

- a). ANY IMPLIED WARRANTY OR CONDITION THAT THE CONTROL WILL MEET YOUR REQUIREMENTS.**
- b). ANY IMPLIED WARRANTY OR CONDITION THAT THE OPERATION OF THE CONTROL WILL BE UNINTERRUPTED OR ERROR FREE; AND**
- c). ANY IMPLIED WARRANTY OR CONDITION OF MERCHANTABILITY OR FITNESS FOR A PARTICULAR PURPOSE.**

The user shall be made aware that if the equipment is used in a manner not specified by the manufacturer, the protection provided by the equipment may be impaired.

**MASTERTRACE™
HEAT TRACING CONTROL**